

Marshall Electronics

Model No. **QV241-HDSDI**
24" Full Resolution Quad-Viewer Monitor

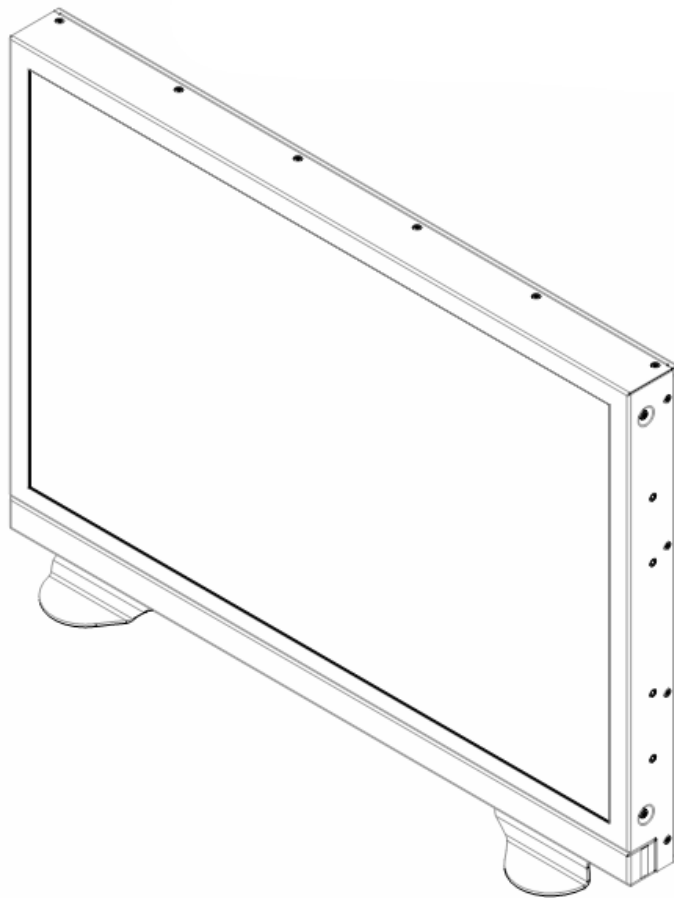

Operating Instructions

This page intentionally left blank

Table of Contents

Product Overview	4
Features	4
Installation and Accessories	5
Monitor Front	6
Monitor Rear	7
Compatible Input Formats	8
Quad / Dual Monitor Layouts	9
Menu and Navigation	11
Using the RotoMenu knob	11
Video Configuration Submenu	13
DVI Configuration Submenu	15
Color Configuration Submenu	16
System Configuration Submenu	17
Full System Restore	18
OSD Configuration Submenu	18
IMD Configuration Submenu	21
IMD Fixed Configuration Submenu	23
Service Submenu	24
Specifications	25
Dimensions	26
Maintenance	27
Warranty	27

Product Overview

The Quad Viewer Series is the latest addition to Marshall's line of IMD-equipped monitors. The monitor features a full resolution 1920 x 1200 LCD panel, built-in high quality HD Quad Splitter, four independent HDSDI inputs, one DVI-I input, IMD (In-Monitor Display) capability, Audio Presence indicator, and Time Code. Video and DVI-I both offer full screen mode, while quad-split mode is scaled to fit onscreen in the highest resolution. IMD and Tally are supported via manual mode, along with Image Video, NVISION, MEI (Marshall), and TSL protocols. Other features include Closed-Caption presence display, front panel user-configurable function buttons, RS-422/485 port with pass-through, and field-upgradeable firmware.

Features

- **1920 x 1200 Full Resolution 24" Panel**

The QV241-HDSDI features an all-digital TFT-MegaPixel active matrix LCD system with 1920x1200 native resolution. The LCD panel features a brightness of 400 cd/m² and a 1000:1 contrast ratio making it ideal in a variety of environments and lighting conditions.

- **Quad-Viewer and Side by Side mode**

Ability to view 4 inputs on the screen at once. Each input source is scaled and positioned in real-time so that all 4 can be seen. DVI-I input can replace HD/SD Ch.4 in this mode. There are 3 different Quad-Layouts from which to choose. Also, the Side by Side mode allows you to select any two consecutive channels to view on the screen at one time. **See Quad / Dual Monitor Layouts Page 9.**

- **In-Monitor Display**

In-Monitor Display allows on-screen text and tally indication, controlled locally or remotely via a variety of industry standard protocols. **See Page 21 : IMD Configuration Submenu.**

- **OSD Features (On Screen Display)**

Embedded time code and an embedded audio presence indicator can be displayed on the screen in a variety of configurations. Closed Caption presence indication is also provided for 608/708 captions. **See OSD Configuration Submenu on Page 18.**

- **Advanced Features**

Color temperature adjustment, aspect ratio settings, blue-only mode, and monochrome mode are a few of the advanced features allowing the QV241-HDSDI to be at home in any broadcast environment. Pixel-to-Pixel mode also allows native display of any incoming image format.

- **User-Definable Function Buttons**

Two user-definable function buttons allow quick access to numerous settings and features including aspect ratio, monochrome mode, color temperature, and more.

Installation and Accessories

Unpacking

Carefully unpack the QV241-HDSI monitor and verify that the following items are included:

- QV241-HDSI Monitor
- V-PS24-7.5 Power Supply with 4-Pin XLR Connector
- Operating Instructions

Accessories

The QV241-HDSI comes with a desktop stand (V-ST23-32).

The QV241-HDSI supports VESA standard 75mm and 200mm devices. Marshall Electronics offers a VESA stand with Pivot capabilities (VP-LCD171H-ST-01).

Monitor Front

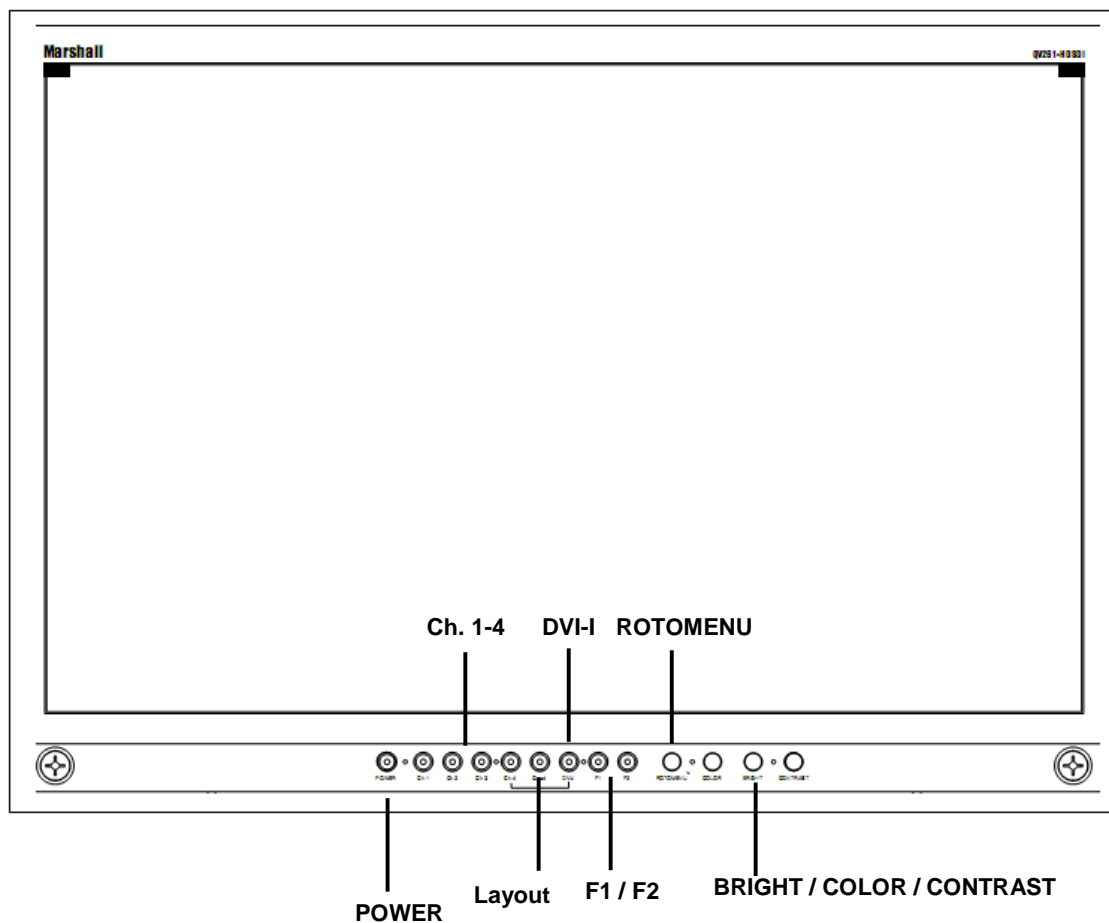

- **[Power]**

Turn the monitor off or on by pressing the power button. The LED on the power button is at full illumination when the monitor is OFF.

- **[Ch. 1-4]**

Pressing Ch. 1, Ch. 2, Ch. 3 or Ch.4 will select HSDI Video Inputs 1, 2, 3 or 4. This also switches the monitor to full screen mode.

- **[Layout]**

Switches the monitor between Quad Modes and Dual Layout.

- **[DVI-I]**

Selects DVI-I input as the video source for Ch. 4. This replaces the HSDI input on Ch. 4. When activated, the LED will light on the DVI-I button.

- **[F1 , F2]**

Two user-definable function buttons can be used for direct access to various settings. Functions are assigned using the on-screen menu.

- **[RotoMenu™]**

The RotoMenu™ knob allows for accessing and navigating the main menu, using only a single knob. **See page 11: Menu and Navigation.**

- **[BRIGHT, COLOR , CONTRAST]**

The BRIGHT, COLOR and CONTRAST knobs function as Image Adjustment knobs. The status of each image adjustment parameter is shown on the top left of the screen, with values ranging from 0 to 100. Pressing a knob once displays the current value. Pressing a knob twice resets the corresponding adjustment to the default setting. Adjusting the knobs while in any of the Quad layouts will adjust either the Main or Window 1 channel.

Monitor Rear

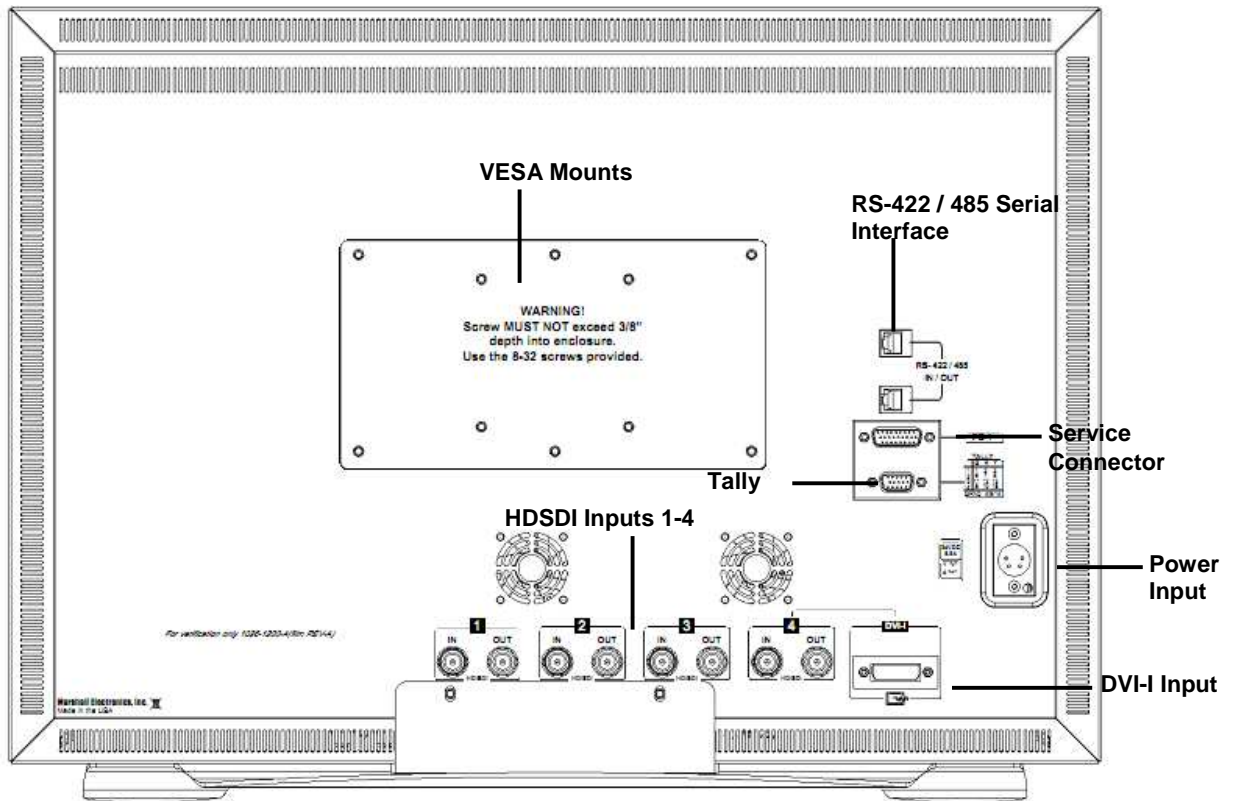

- **VESA Mounts**

VESA standard 75 mm and 200 mm hole patterns are provided to accommodate a variety of custom mounting options.

- **RS-422 / 485 Serial Interface**

The RS-422/485 ports are used to remotely control the IMD or all QV241-HDSI features using a variety of industry standard protocols. Only one connection to either port is needed to control the monitor. The second port can be used to loop multiple IMD capable monitors in the same bus.

- **Service Connector**

DO NOT USE. This is for factory use only. Connecting any device to this port may damage the unit.

- **Tally**

The OSD tally can be activated via the HD-15 connector by connecting the corresponding pin to ground. A variety of external devices can be used to perform the contact closure. No

additional power should be supplied to the HD-15 port.

- **Power Input**

Connect the 24 VDC output to the XLR power input connector. Power can be supplied from the included power supply or from a variety of DC sources supplying at least 6.0 Amps at 24 Volts.

Important: If using a power source other than the included power supply, be sure that the polarity of the DC output is correct.

- Pin 1: Ground
- Pin 2: N/C
- Pin 3: N/C
- Pin 4: +24 VDC

- **HDSI Inputs and Output Connector**

The QV241-HDSI has four HDSI inputs and four active loop-through outputs.

- **DVI-I Input Connector**

Integrated DVI Digital and Analog input. Includes EDID and HDCP for connection to Computers, DVD Players, Rasterizers, etc.

Compatible Input Formats

The following SDI standards are supported by the QV241-HDSDI:

525i, 625i
1035i/60, 1035i/59.94
1080i/60, 1080i/59.94, 1080i/50
1080psF/24, 1080psF/23.98
1080p23.98, 1080p/24, 1080p/25, 1080p/29.97, 1080p/30
720p/60, 720p/59.94, 720p/50
720p/23.98, 720p/24, 720p/25, 720p/29.97, 720p/30

The following VESA standards are supported by the QV241-HDSDI (DVI-I input):

640x480 @60Hz
800x600 @60Hz
1280x1024 @60Hz
1680x1050 @60Hz
1600x1200 @60Hz

The following DVI-Video standards are supported by the QV241-HDSDI (DVI input):

525i, 625i
480p/59.94, 576p/50
1035i/60, 1035i/59.94
1080i/60, 1080i/59.94, 1080i/50
1080p/23.98, 1080p/24, 1080p/25, 1080p/29.97, 1080p/30
720p/60, 720p/59.94, 720p/50

Quad / Dual Monitor Layouts

The QV241-HSDSI can display 4 different input sources simultaneously. Each source is scaled and positioned to fit the desired layout. There are a total of 4 different layouts illustrated below. Each press of the [Layout] Button will change the current layout to the next available layout. When in Quad Mode, Ch.4 video source can be changed to be the DVI-I source at any time by pressing the DVI-I Button. This will illuminate the DVI-I Button LED. Any HSDSI Video Source connected to HSDSI Input 4 will not be viewable when the DVI-I LED is lit.

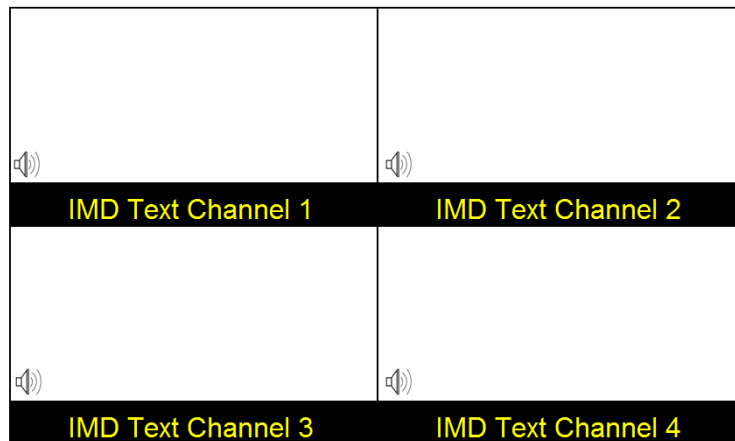

Default Quad Layout

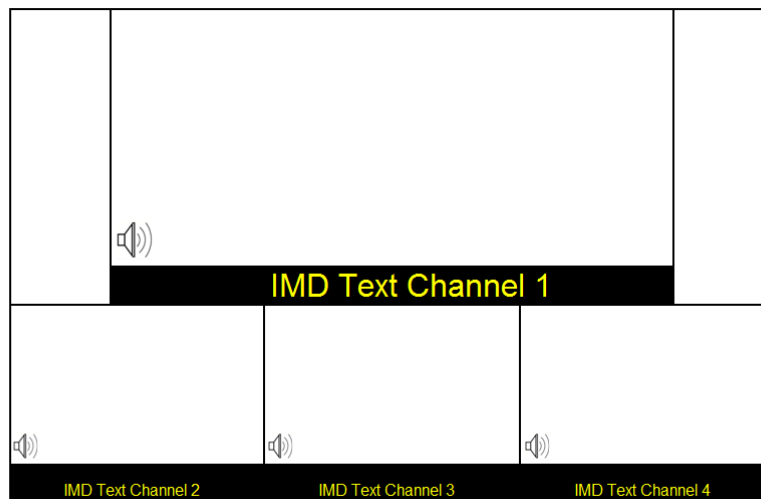

Quad Layout 2

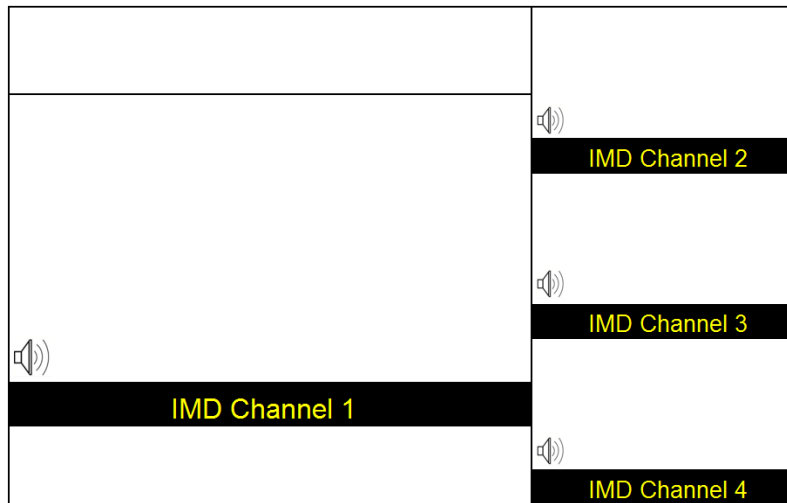

Quad Layout 3

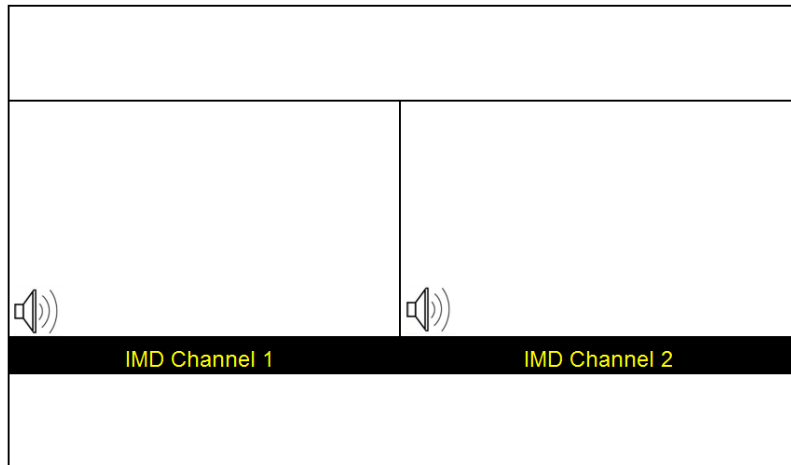

Layout 4

Menu and Navigation

Access and navigate the main menu using the RotoMenu™ knob:



Main Menu

Using the RotoMenu knob

- Press the **RotoMenu™** knob to enter the main menu.
- Rotate the knob to scroll up or down in the main menu or each submenu.
- Press the **RotoMenu™** knob to enter a submenu or choose a setting.
- To return to main menu from submenu, select 'Back' and press the **RotoMenu™**.

The menu timeout can be set in the OSD Timeout section of the OSD Config submenu.

Making changes to individual channels

The Quad-Viewer RotoMenu allows for Video, Color, System, OSD and IMD Configuration changes to be made to individual channels in the Quad-Viewer system. Items in the menu that can be changed for each individual channel will have a Ch1, Ch2, Ch3, Ch4 indicator row on the top of the right column and an icon for each channel. The icons include check boxes, color patches, and aspect ratio icons.

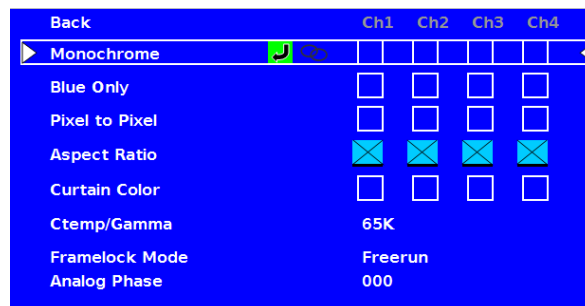

To modify an individual channel, select the particular submenu you would like to modify (in this case, the Monochrome option) by turning your RotoMenu left or right from the screen above.

Your current position in the menu is indicated by the green highlight. When you have highlighted the particular channel you would like to modify, press the RotoMenu knob. The box you have selected will change, indicating that this channel is now your choice to be modified, as shown below:

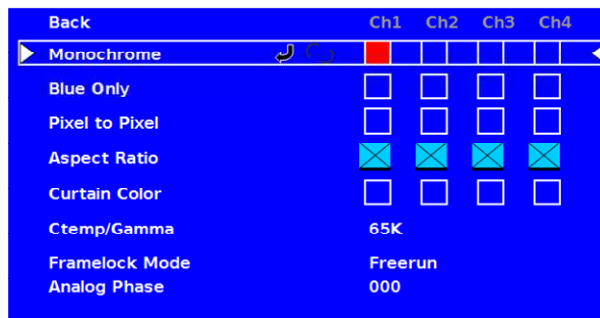

To apply a change to the particular channel, turn your RotoMenu left or right after you have selected a channel (the channel is highlighted in red). If the item you have chosen is active, an X will appear in the chosen channel check box. If the setting is inactive, the check box will be empty.

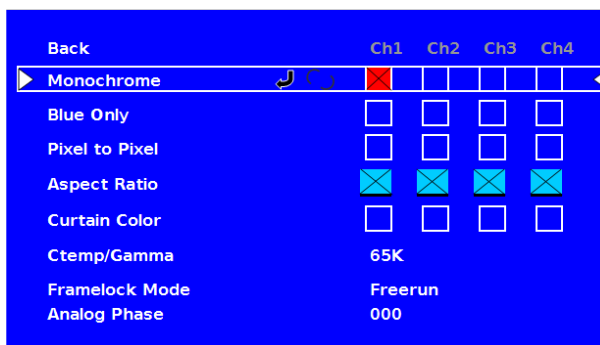

To move away from modifying an individual channel, simply press the RotoMenu button again. When the channel box is highlighted green again, you will know you are free to access any other channel or option.

Group Changes / Link Option

The RotoMenu also allows for changes to input Channels as a group, known as Group Linking. If a menu item can be applied to multiple channels, the group link option will be shown as follows:



In this image, the Monochrome option in the Video Config submenu is being accessed. By turning the RotoMenu left and right, the Back arrow, Group Link icon and each of the four individual channels can be accessed. The green highlight indicates your current position in the menu. In this case, the current RotoMenu position is over the Group Link icon.

To turn the Group Link option on from the above state, simply press the RotoMenu knob. The Group Link Icon will change from a broken Group Link icon to a completed Group Link icon, as shown below:

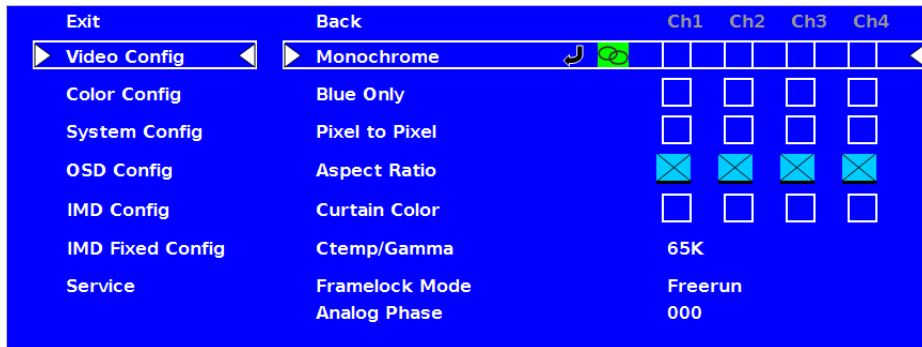

The completed Group Link icon indicates that any change that you make to an individual channel, as shown section before this, will be applied to all other channels. To turn this off, simply highlight the Group Link icon again and press the RotoMenu knob.

All Submenu options that can be Group Linked will be referenced with a  throughout these Operating Instructions.

Video Configuration Submenu



Video Configuration Submenu

■ Monochrome Mode

Use this setting to enable monochrome mode. Only the luminance of the image will be displayed as a grayscale picture.

■ Blue-Only Mode

Use this setting to enable Blue-Only mode. This mode displays only the blue color component of the image, switching off the red and green components. Use this mode when calibrating the monitor to SMPTE color bars with the following procedure:

1. Allow the monitor to warm up for at least 5-10 minutes.

2. Display SMPTE split-field color bars on the monitor using an external source.
3. Enable **Monochrome mode**.
4. Locate the pluge pattern (super black, black, and gray bars) at the lower-right corner of the screen. Adjust the **Brightness** knob until there is no visible difference between the super black and black bars, but the gray bar is still visible.
5. Adjust the **Contrast** knob until an even grayscale appears along the top bars.
6. Disable **Monochrome mode**.
7. Enable **Blue-Only mode** and adjust the **Color** knob so that the outermost bars (white and blue) appear to match in brightness.

■ Pixel-to-Pixel Mode

Use this setting to enable Pixel-to-Pixel mode.

This mode bypasses the monitor's internal scaling function and displays images in their native resolution and aspect ratio, with a one-to-one mapping of incoming image pixels to screen pixels:

- For incoming formats smaller than the native resolution of the window (or selected aspect ratio), the image will be displayed in the center of the window using only the necessary LCD pixels. For example, 480i images will only occupy exactly 640x480 pixels in a particular channel window in Quad mode, or if the channel is selected full screen, it will occupy exactly 640x480 pixels in the center of the screen. The surrounding screen area will be black.

■ Aspect Ratio Settings

Use this menu option to switch between several aspect ratio settings.

As the QV241-HDSDI monitor has a native resolution of 1920x1200 RGB pixels, incoming images are automatically scaled to fit the screen:

- In **4:3** mode, images are scaled up or down to fill the maximum 4:3 portion of the screen (1600 x 1200 in Full Screen). IMD text and time code are superimposed on the lower portion of the image. The audio presence indicator and on-screen tally are displayed at the bottom of the screen, outside the image.
- In **Scaled 4:3** mode, images are scaled to a smaller 4:3 portion of the screen, leaving space for IMD text, tally, and audio presence indicator to be displayed below or around the image. Time code is superimposed on the lower portion of the image.
- In **16:9** mode, images are scaled to fill the maximum 16:9 portion at the top of the screen (1920 x 1080 in Full Screen). In this mode, IMD text and on-screen tally are displayed below the image. Time code and the audio presence indicator are superimposed on the lower portion of the image.
- In **Full Screen (16:10)** mode, images are scaled to fill the entire 16:10 screen (1920 x 1200 in Full Screen). In this mode, all OSD features are superimposed on the image. **Note that when using a 16:9 input image in this mode, the image will be vertically stretched by approximately 10%.**

The diagrams on the following page show how IMD text, timecode, and the audio monitor icon are simultaneously displayed on the screen in each aspect ratio setting. The white area represents the video image.

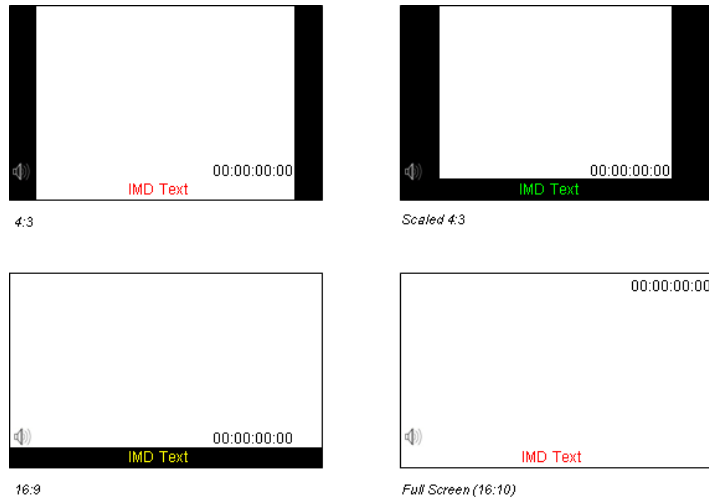

■ Curtain Color

Use this setting to choose the default color displayed on the screen when no video input is present. Available colors are **blue**, **red**, **green**, **white**, and **black**.

■ Ctemp/Gamma

Use this setting to choose one of three color temperatures / gamma presets or to remove gamma application:

- Linear (No gamma applied)
- 55K
- 65K
- 93K

■ Framelock Preference

Used to designate the Primary Channel as a reference for synchronizing image scaling when in any Quad Mode. The Primary Channel will always be Ch. 1 in the default Quad Layout. In Quad Layouts 2 and 3, the biggest window is the Primary Channel. In Quad Layout 4, the Primary Channel is the window on the left side. Framelock allows the monitor to use a known-stable input source as a reference-lock to the entire system. This can improve performance when 1 or more inputs are frequently switched and are non-synchronous. Under some conditions, selecting Off will reduce the time needed for image lock.

DVI Configuration Submenu

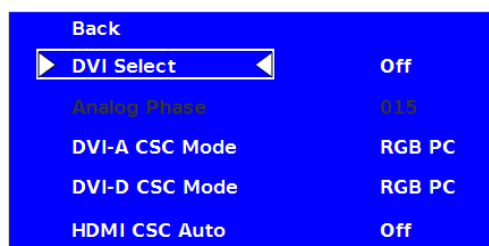

DVI Conguration Submenu

■ DVI Select

Use this to select the DVI-I input as the Ch. 4 video input by setting this to On. Setting this to Off makes HSDI Input 4 the video source for Ch. 4.

■ Analog Phase (DVI-Analog or VGA input only)

Adjusts the analog phase value to improve picture quality on DVI-A or VGA Sources. This adjusts the signal phase (not color phase) of the analog-to-digital conversion.

- 0-31 (value)

■ DVI-A CSC Mode (DVI-Analog input only)

Use the DVI-A CSC Mode to accommodate for four different types of colorspace inputs. This setting will only affect your DVI-A inputs.

- RGB Studio: accommodates digital 480i video using the RGB limited range (16-235) inputs.
- RGB PC: accommodates full range RGB (0-255) inputs.
- YUV 601: accommodates for Rec. 601 SDTV YUV colorspace inputs.
- YUV 709: accommodates for Rec. 709 HDTV YUV colorspace inputs.

The monitor's default setting is RGB PC.

■ DVI-D CSC Mode (DVI-D input only)

Use the DVI-D CSC Mode to accommodate for four different types of colorspace inputs. This setting will only affect your DVI-D and HDMI inputs.

- RGB Studio: accommodates digital 480i video using the RGB limited range (16-235) inputs.
- RGB PC: accommodates full range RGB (0-255) inputs.
- YUV 601: accommodates for Rec. 601 SDTV YUV colorspace inputs.
- YUV 709: accommodates for Rec. 709 HDTV YUV colorspace inputs.

The monitor's default setting is RGB PC.

■ HDMI CSC Auto (HDMI input only, via the DVI-I interface)

The HDMI CSC Auto setting is used to accommodate newer HDMI interfaces that send colorspace signaling in the HDMI data stream. If this setting is set to **On**, the monitor will automatically determine which colorspace setting to use. If this setting is set to **Off**, or your HDMI signal does not contain colorspace signaling, the DVI-D CSC Mode described above will determine the colorspace configuration.

Color Configuration Submenu

Use the Color Configuration submenu to adjust the Red, Green and Blue Offset and Gain values of all four HD/SDI channels, the DVI-D input and DVI-A input.

Back	Ch1	Ch2	Ch3	Ch4	DVID	DVIA
▶ Red Offset ◀	050	050	050	050	050	050
Green Offset	050	050	050	050	050	050
Blue Offset	050	050	050	050	050	050
Red Gain	050	050	050	050	050	050
Green Gain	050	050	050	050	050	050
Blue Gain	050	050	050	050	050	050
Reset	Back					

Each column adjusts a particular input channel, from HD/SDI Ch1-Ch4 to the DVI-I input. For the DVI-I input, you can adjust the Offset and Gain for either a DVI-D or DVI-A input.

The Reset option allows you to return to the default settings for each individual channel.

System Configuration Submenu

Back	
▶ Function 1 ◀	Monochrome
Function 2	Aspect Ratio
Load Config	Back
Save Config	Back

System Configuration Submenu

■ User-Definable Function Buttons

Use the **Function 1** and **Function 2** menu items to define each function button on the front panel of the monitor. The following options are available for each button:

- IMD State Display/hide IMD text
- Anc. Time Code Display/hide time code
- OSD Tally Rotate amongst types of OSD Tally
- Audio Monitor Display/hide audio presence indicator
- CC Monitor Display/hide CC presence indicator
- Aspect Ratio Toggle between 4:3 and 16:9 aspect ratios
- Pixel to Pixel Enable/disable Pixel-to-Pixel mode
- Ctemp/Gamma Rotate amongst color temperature settings
- Blue Only Enable/disable Blue Only mode
- Monochrome Enable/disable Monochrome mode

■ Saving and Loading User Presets

Use the SAVE CONFIG and LOAD CONFIG menus to save current settings to one of 6 presets, or load a preset. Each Preset saves all monitor settings except for IMD configuration.

- Use the LOAD CONFIG menu to load one of presets USR1 – USR6. Factory default settings can also be loaded by selecting MFG. (Factory defaults cannot be overwritten.)
- Use the SAVE CONFIG menu to save the current settings to a preset from USR1- USR6.

Full System Restore

Use To perform a full system restore, which resets ALL adjustable fields on the monitor to their “fresh-from-factory” state, press the Power, F1 and F2 button simultaneously. **Note: You will lose ALL user adjustable settings on your monitor.**

OSD Configuration Submenu

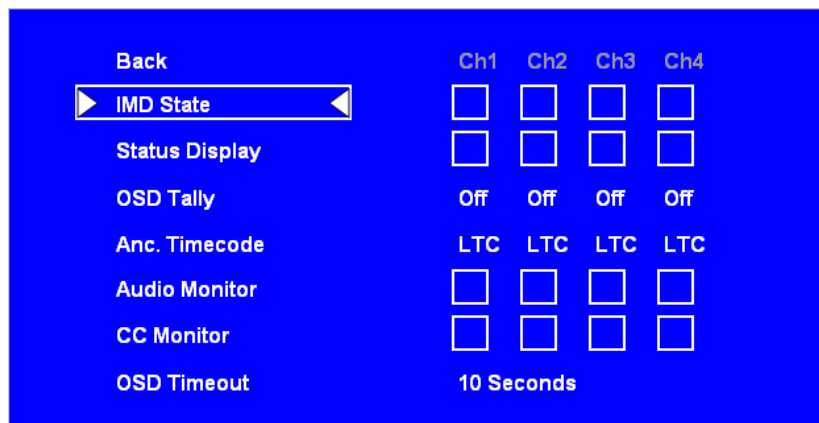

■ IMD State

Use this setting to turn the IMD text display on or off. This setting affects both fixed string IMD text and remote IMD text commands

■ Status Display

Use this setting to enable or disable status display. When enabled, the current video input standard is displayed on the top left of the screen. When disabled, status is only displayed for 2 seconds when the monitor is powered on, when an input is applied, or when the input video standard changes. The status display reads “No Input” when no video input is present.



■ **OSD Tally** 

Use this setting to choose how tally is displayed on the screen. The available OSD Tally options depend on the Tally Source selected in the IMD Configuration submenu (**see page 22**).

When the Tally Source is set to Standard (contact closure), OSD Tally can be set to **Off**, **RGY**, **RG**, or **GR**:

- Off On-screen tally is disabled
- RGY Red, yellow, or green tally signals are indicated at both the bottom left and bottom right corners of the screen. Two or three colors are shown simultaneously by subdividing each tally indicator
- RG Red tally is shown at the bottom left of the screen, and green is shown at the bottom right.
- GR Green tally is shown at the bottom left of the screen, and red is shown at the bottom right.

The following diagrams show RGY, RG, and GR OSD Tally modes:

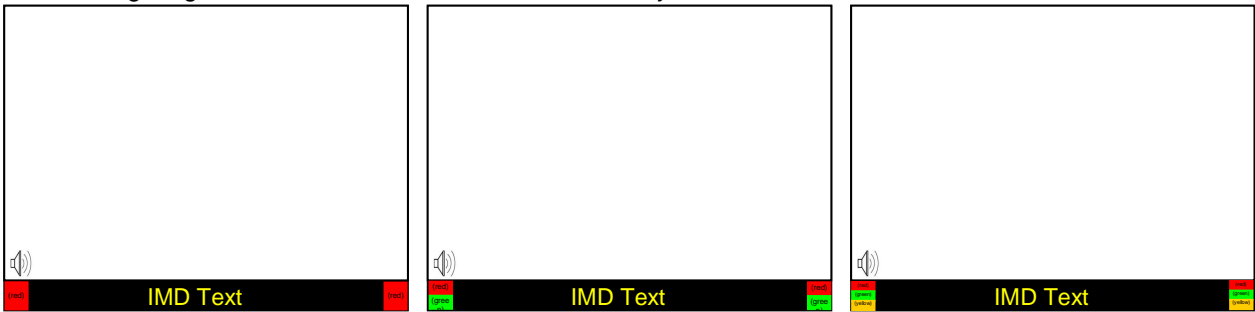

RGY mode: single color activated

RGY mode: two colors activated

RGY mode: three colors activated

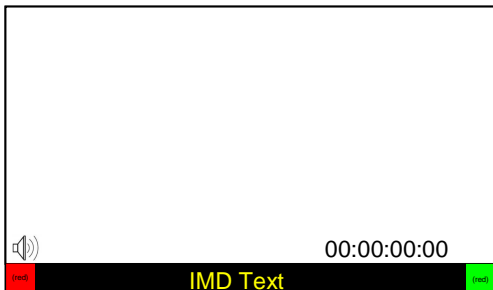

RG Mode: both colors activated

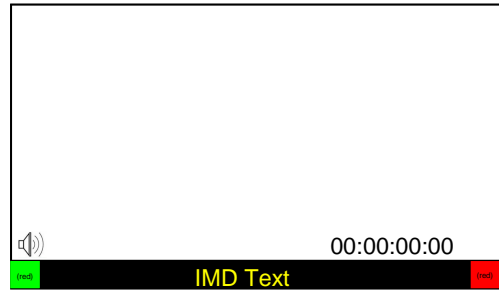

GR Mode: both colors activated

When the Tally Source is set to TSL/MEI 422, OSD Tally can be set to **Off** or **IMD**:

- Off On-screen tally is disabled
- IMD Red, yellow, and green tally is displayed according to the protocol commands. Green, red, and yellow colors are shown individually on either the bottom left or right of the screen.

■ **Anc. Time Code** 

Use this setting to enable time code display on the screen. Time code is de-embedded from the vertical ancillary data (VANC) within the HD/SDI signal. Two types of time code can be selected to display on the screen: **LTC (linear time code)** or **VITC (vertical interval time code)**.

The position of the time code display varies based on the aspect ratio setting and presence of IMD text



■ Audio Monitor

Use the Audio Monitor menu option to enable or disable the audio presence indicator icon. When enabled, this icon indicates whether embedded audio is present in the HD/SDI video input. A red circle and cross will flash on the icon if no embedded audio is present.

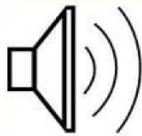

Embedded Audio Present



No Embedded Audio

■ CC Monitor (Closed Captioning)

Use the CC Monitor menu option to enable or disable the Closed Captioning presence indicator icon. When enabled, this icon indicates the presence of 608 and/or 708 embedded Closed Captioning in the SDI video input. A green dot indicates the presence of CC Data. A red dot indicates no captioning data.

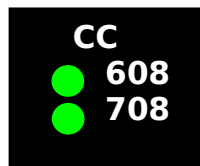

Both 608 and 708 CC Data present

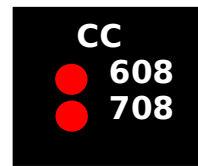

No CC Data present

■ OSD Timeout

Use the OSD Timeout setting to set the amount of time you would like to see the Menu on screen. Values from **5** to **30** seconds, in 5 second increments, are available. A value of **None** allows the menu to stay on screen until it is manually exited.

IMD Configuration Submenu

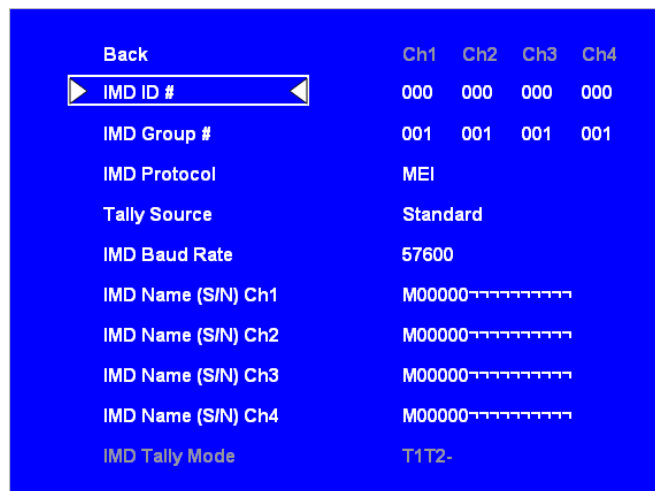

The QV241-HDSDI features an In-Monitor Display (IMD) with the ability to display on-screen text and tally in three colors. IMD text, color, and alignment can be assigned to each screen locally using menu options (see below). Alternately, IMD text and tally can be remotely controlled via the RS-422/485 serial interface using several industry-standard protocols, including TSL v4.0 and Image Video. Multiple QV241-HDSDI monitors can be looped together and each addressed individually via the protocol. All menu features of the QV241-HDSDI can also be controlled via the Marshall Network Controller box using MEI protocol. (Contact Marshall Electronics for additional information).

Use the IMD Configuration submenu to configure various IMD parameters as described below.

■ IMD ID

The IMD ID # identifies each screen to the controlling device. When using the TSL protocol, the ID # of each screen should be manually set in conjunction with the controlling device. When using the Image Video protocol, the ID # may be set automatically by the controlling device, after each IMD is initially identified by IMD Name (see "IMD Name[S/N]" below). Available ID #s are **000-254**.

■ IMD Group

Each screen can be assigned an IMD Group # when using the Marshall protocol. Available Group #s are **01-254**.

■ IMD Protocol

Use the IMD Protocol menu option to choose the protocol with which the QV241-HDSDI receives remote commands. Currently, four protocols are available. Contact Marshall Electronics for the latest protocol compatibility.

Image Video

Use the Image Video protocol setting when controlling the IMD from an Image Video tally controller (e.g. TSI-1000) or other controlling device which utilizes the Image Video protocol. The **IMD #**, **IMD Name(S/N)**, and **Baud Rate** parameters must be set for each screen in conjunction with the controlling device.

TSL v4.0

Use the TSL v4.0 protocol setting when controlling the IMD from a TSL tally controller, or other controlling device which utilizes the TSL v4.0 protocol. The **IMD #** must be set for each screen in conjunction with the controlling device.

MEI

Use the MEI protocol setting when controlling the QV241-HDSDI using the Marshall Network Controller box. This protocol allows remote control of all features on the QV241-HDSDI, including marker setup, video configuration, system configuration, and image adjustments (brightness, contrast, etc.). The **IMD #**, **IMD Group #**, and **Baud Rate** parameters must be set in conjunction with the Network Controller Box.

MEI-Image Video

This protocol setting accepts Image Video commands *via* MEI protocol, for use when an Image Video controller is connected to the Marshall Network Controller box.

■ Tally Source

The QV241-HDSDI OSD tally can be controlled in a variety of different ways. Use the Tally Source setting to choose how tally is controlled:

Standard

Use the Standard setting to control tally via contact closure on the HD-15 tally interface.

Image Video HW

Use the Image Video HW setting to control Image Video tally states via contact closure on the HD-15 tally interface. Contact closure of the **Red** pin corresponds to **Image Video Tally 1**, and the **Green** pin maps to **Image Video Tally 2**. Contact closure (ground) corresponds to a LOW state, and open circuit corresponds to a HIGH state. This mode requires the IMD Tally Mode parameter to be set. Consult Image Video documentation for further information.

Image Video 422

Use the Image Video 422 setting to control Image Video tally states via the Image Video serial protocol. OSD tally will be disabled in this mode, as Image Video tally states are manifested in the text color and other parameters. This mode requires the IMD Tally Mode parameter to be set. Consult Image Video documentation for further information.

Standard + IV422

Use the Image Video 422 setting to control Image Video tally states via the Image Video serial protocol, while controlling OSD tally using contact closure on the HD-15 tally interface. This mode requires the IMD Tally Mode parameter to be set. Consult Image Video documentation for further information.

TSL/MEI 422

Use the TSL/MEI 422 setting to control OSD tally via the TSL or Marshall serial protocols.

■ IMD Baud Rate

Use this setting to choose the baud rate. The baud rate must be set in conjunction with the controlling device. Available baud rates are **300, 600, 1200, 2400, 4800, 9600, 19200, 38400, 57600, 115200**. The TSL v4.0 protocol is fixed at 38400 bauds.

■ **IMD Name (S/N)**

Use this setting to assign a name to each screen when using the Image Video or Marshall-IV protocols. **The IMD name is equivalent to the Image Video serial number and is used by the Image Video controlling device to identify each screen.** The default IMD Name(S/N) is "M00000." It is recommended to maintain this naming scheme in order to avoid serial number conflicts with other Image Video devices on the same serial bus. Each name can be up to 16 ASCII characters.

Press RotoMenu™ knob to edit the IMD Name. Rotate the RotoMenu™ knob to move the cursor. Press the RotoMenu™ knob with the cursor on the character to be changed, then rotate the knob to scroll through the character set. Press the RotoMenu™ knob to choose a character.

By exiting the edit field in a particular IMD Name or IMD Fixed String field, you are confirming the changes you have made. Before confirming a change, you have the ability to cancel any changes you have made by highlighting the Red Cancel icon next to the name of the field you are editing. This will return your IMD Name or IMD Fixed String back to the last confirmed values.

■ **IMD Tally Mode**

Use this setting when using Image Video tally control. Choose one of the following settings, in conjunction with the Image Video controlling device. **T1, T2, T1T2, T2T1, T1-, T2-, T1T2-, T2T1-**. Consult Image Video documentation for further information.

IMD Fixed Configuration Submenu

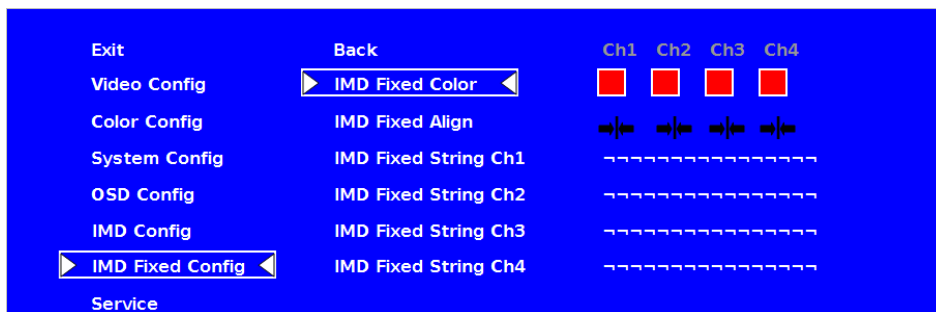

■ **IMD Fixed Color** 

Use this setting to choose the color of the IMD Fixed String text (see below). Available colors are **red**, **green**, and **yellow**. This setting does not affect text color when using IMD text via the Image Video or TSL v4.0 protocols (text color is set via the protocols).

■ **IMD Fixed Align** 

Use this setting to choose the horizontal alignment of the IMD text. IMD text can be justified on the **left**, **center** or **right** of the screen. This setting is overridden when using IMD text via the Image Video protocol (alignment is set via Image Video protocol).

■ IMD Fixed String

Use this setting to display static IMD text on the screen. This setting is used to enter IMD text locally, when a serial protocol is not used for remote control. The IMD Fixed String is saved after power cycle. *The IMD Fixed String will be overridden by serial protocol commands.*

Press RotoMenu™ knob to edit the IMD Fixed String. Rotate the RotoMenu™ knob to move the cursor. Press the RotoMenu™ knob with the cursor on the character to be changed, then rotate the knob to scroll through the character set. Press the RotoMenu™ knob to choose a character. The '-' character indicates an unused (NULL) value in the string. The string entered will be terminated by the first '-'. Characters to the right of a '-' character will be displayed in the menu, but will not be shown in the IMD string.

By exiting the edit field in a particular IMD Name or IMD Fixed String field, you are confirming the changes you have made. Before confirming a change, you have the ability to cancel any changes you have made by highlighting the Red Cancel icon next to the name of the field you are editing. This will return your IMD Name or IMD Fixed String back to the last confirmed values.

Service Submenu

■ Software Version Display

The Main Board, Keypad, and FPGA software version numbers are displayed.

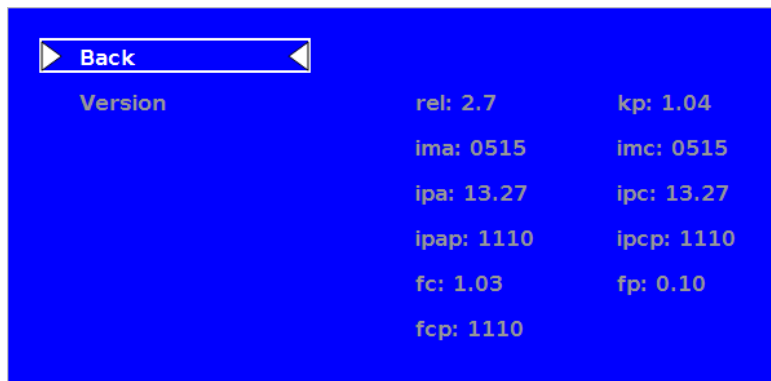

Service Menu

The following information is displayed:

- Rel: Software Release version
- Ima: A/B Input Module version
- Ipa: Image Processor version
- Ipap: Image Processor model number
- Fc: Combiner FPGA version
- Fcp: FPGA model number
- Kp: Keypad version number
- Imc: C/D Input Module version
- Ipc: Image Processor version
- Ipcp: Image Processor model number
- Fp: Packet Decoder FPGA version

Specifications

■ PANEL

Screen Size	24.1" Diagonal
Display Area (h x v)	518.4 x 324.0 mm
Aspect Ratio	16:10 Native
Pixels	1920 x RGB x 1200
Color Depth	8-bit
Viewing Angle (h x v)	178° x 178°
Brightness	400 cd/m ²
Contrast Ratio	1000:1
Pixel Pitch (h x v)	0.270mm x 0.270mm

Burn-In Warning

The QV241-HDSDI uses a high quality TFT LCD panel. However, if a static image is left on the screen for 48 hours, there may be a 10 to 20 minute recovery period for the panel. During recovery, a very faint image may be retained on the display. Put up a white curtain for 30 minutes to eliminate the retained image.

■ VIDEO INPUT/OUTPUT

HD-SDI Input / Output

Supports ITU-R BT.656, SMPTE 259M, 292M, 274M

DVI-I Video/VESA input

■ CONNECTORS

HD-SDI Video Input

4 x BNC Female (75 Ω)

HD-SDI Video Output (Active Loop-Through)

4 x BNC Female (75 Ω)

DVI-I Video/VESA input

1 x DVI-I Female connector

Power Input

4-Pin XLR Connector

Tally Hardware Interface

HD-15 Female

RS-422/485 Interface

2 x RJ12 (Modular 6P6C)

RoHS

Do not dispose. Return to Manufacturer or Authorized Recycle Facility.

■ TALLY HARDWARE INTERFACE (HD-15)

Activation requires contact closure of pin to ground on the HD-15 connector:

Pin No.	Signal
1	Channel 1 Green
2	Channel 1 Red
3	Channel 1 Yellow
4	Ground
5	Channel 4 Green
6	Channel 2 Green
7	Channel 2 Red
8	Channel 2 Yellow
9	Ground
10	Channel 4 Red
11	Channel 3 Green
12	Channel 3 Red
13	Channel 3 Yellow
14	Ground
15	Channel 4 Yellow

■ RS-422/485 SERIAL INTERFACE (RJ12)

Protocols: Image Video, TSL v4.0, MEI

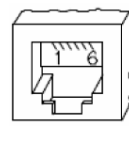

Pin No.	Signal
1	Tx-
2	Ground
3	Rx+ (Receive from host)
4	Rx- (Receive from host)
5	N/C
6	Tx+

■ ELECTRICAL

Power Consumption 132 W
Voltage Requirement 24 VDC

V-PS24-7.5 Power Supply:

Input 100V-240V, 2.5A, 50-60Hz
Output 18-24VDC, 7.5A, 150W Max

■ MECHANICAL

Dimensions (w x h x d): 21.86" x 15.09" x 2.21"

Weight (with rack ears): 15.5 lbs

Operating Temperature 32°F to 120°F (0°C to 40 °C)
Storage Temperature -4°F to 120°F (-20°C to 50°C)

Compliance CE, FCC-Class A, ANSI-63.4
(Certificates on file)

Dimensions

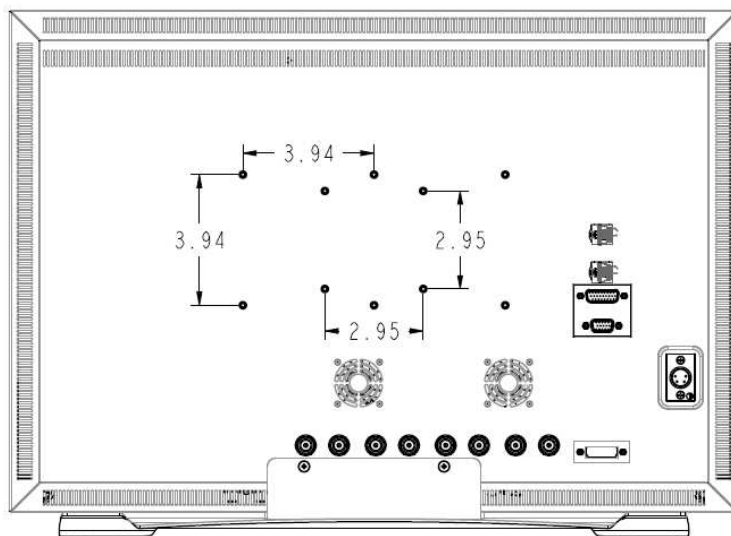
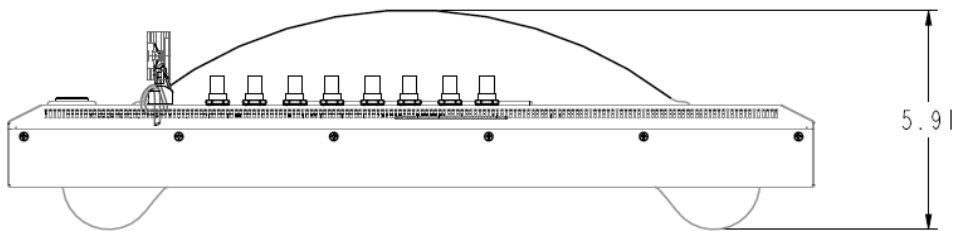
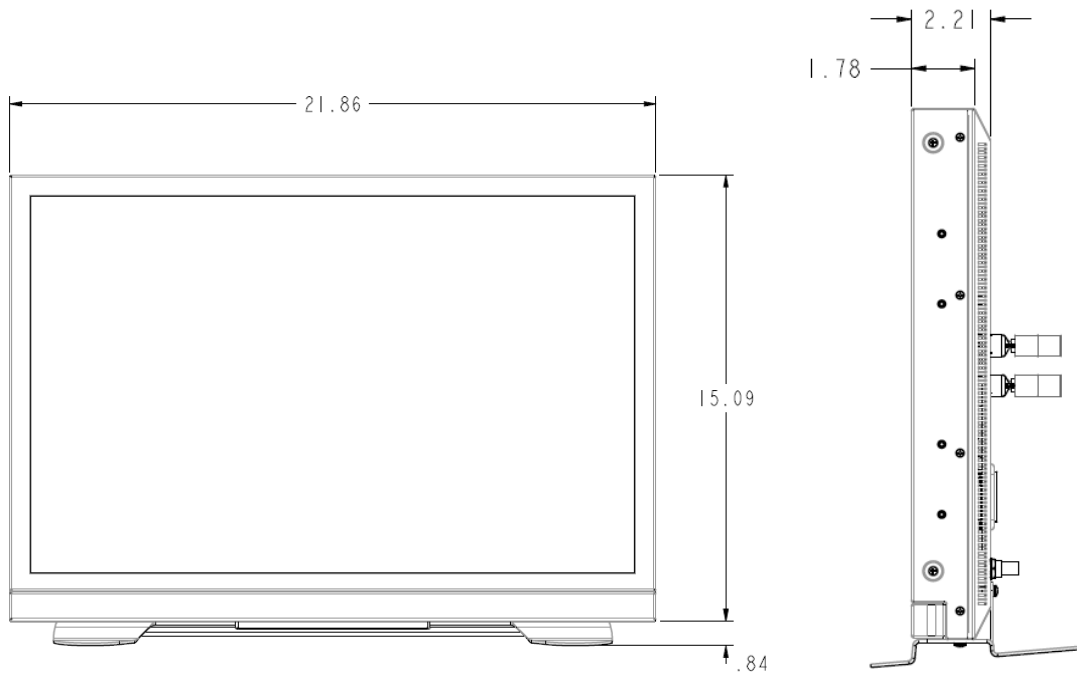

Maintenance

■ Screen Cleaning

Periodically clean the screen surface using ammonia-free cleaning wipes (Marshall Part No. **V-HWP-K**). A clean micro-fiber cloth can also be used using only non-abrasive and ammonia-free cleaning agents. Do not use paper towels. Paper towel fibers are coarse and may scratch the surface of the polycarbonate faceplate or leave streaks on the surface. Antistatic and fingerprint resistant cleaning agents are recommended. Do not apply excessive pressure to the screen to avoid damaging the LCD.

■ Faceplate Dusting

Dust the unit with a soft, damp cloth or chamois. Dry or abrasive cloths may cause electrostatic charge on the surface, attracting dust particles. Neutralize static electricity effects by using the recommended cleaning and polishing practice.

Warranty

Marshall Electronics warrants to the first consumer that this **QV241-HDSI** LCD monitor will, under normal use, be free from defects in workmanship and materials, when received in its original container, for a period of one year from the purchase date. This warranty is extended to the first consumer only, and proof of purchase is necessary to honor the warranty. If there is no proof of purchase provided with a warranty claim, Marshall Electronics reserves the right not to honor the warranty set forth above. Therefore, labor and parts may be charged to the consumer. This warranty does not apply to the product exterior or cosmetics. Misuse, abnormal handling, alterations or modifications in design or construction void this warranty. *It is considered normal for a minimal amount of pixels, not to exceed three, to fail on the periphery of the display active viewing area.* Marshall Electronics reserves the option to refuse service for display pixel failure if deemed unobtrusive to effective use of the monitor by our technicians. No sales personnel of the seller or any other person is authorized to make any warranties other than those described above, or to extend the duration of any warranties on behalf of Marshall Electronics, beyond the time period described above. Due to constant effort to improve products and product features, specifications may change without notice.

Marshall Electronics, Inc.

1910 East Maple Ave.

El Segundo, CA 90245

Tel: (800) 800-6608 / (310) 333-0606 • Fax: 310-333-0688
www.LCDRacks.com • sales@lcdracks.com

2010-1004