

Marshall Electronics

 orchid **OR-701A**

7.0" Full Featured Rack Mount Audio / Video Monitor System

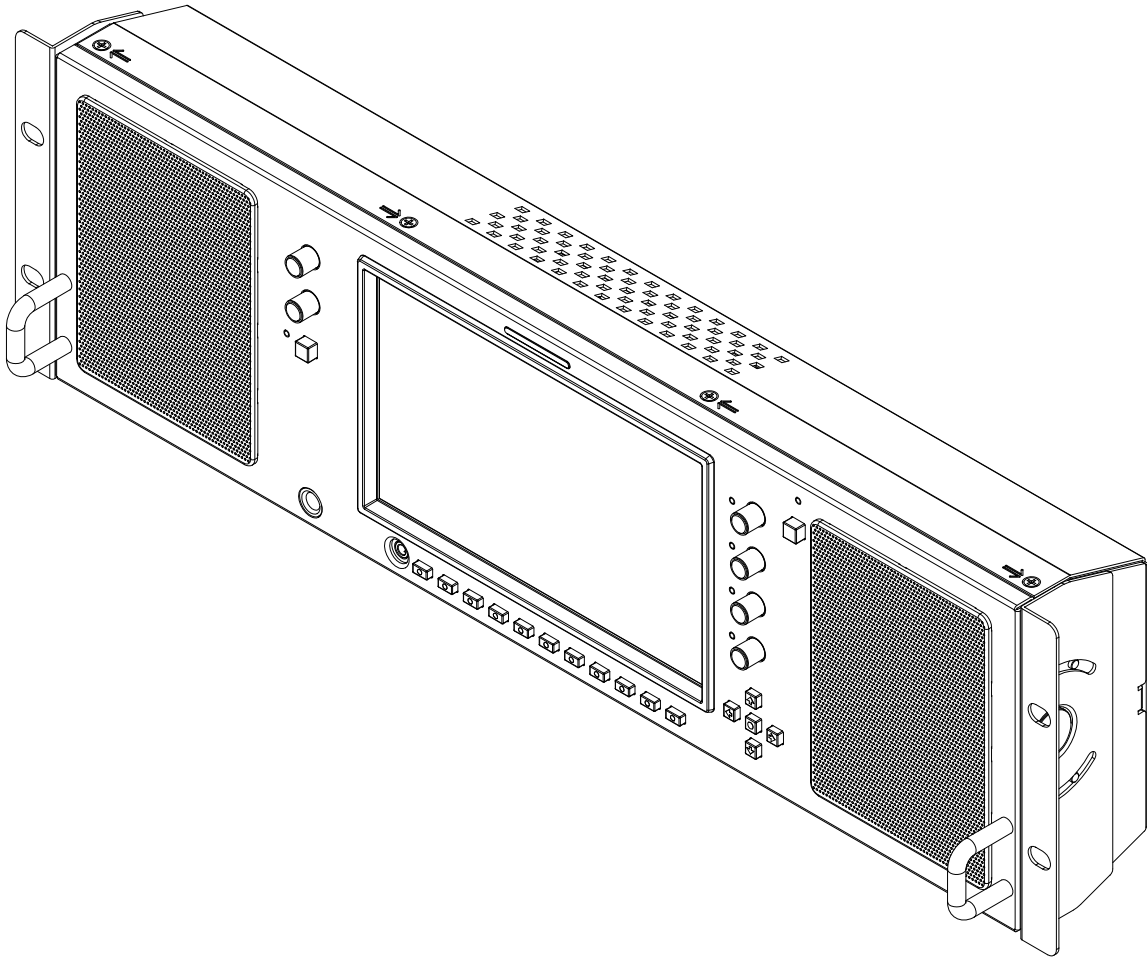

Operating Instructions

Contents

Product Overview	3	<i>Meter Columns</i>	16
Features	3	<i>Display Type</i>	16
Installation and Initial Setup	5	<i>Front Volume</i>	16
Unpacking	5	<i>Rear Volume</i>	16
Mounting	5	<i>Headroom Start</i>	16
Connections and Power-On	5	<i>Headroom End</i>	16
Front Panel Features	6	<i>Channel Assignment</i>	16
Power Button	6	<i>Load CH Preset</i>	16
Tally Lights	6	<i>Save CH Preset</i>	17
User-Definable Function Buttons	6	<i>CH Preset</i>	17
Rotary Encoders	6	WAVEFORM SUBMENU	17
Menu & Volume Control Buttons	6	Layout	17
Headphone Jacks	6	Waveform	17
Speaker Controls	6	Size	17
Rear Panel Features	7	Position	17
GPI Input	7	Display Type	17
Service Port	7	Y Over Limit	17
Power Input	7	Y Under Limit	17
Optional Input Port	7	VECTORSCOPE SUBMENU	18
3.5mm Audio Output	7	Layout	18
Video Input Connectors	7	Vectorscope	18
Video Output Connectors	7	Size	18
Balanced Audio Outputs	7	Position	18
Compatible Input Formats	8	Display Type	18
On-Screen Menu	9	Gain	18
MAIN MENU AND NAVIGATION	12	CLIPGUIDE SUBMENU	18
INFO SUBMENU	12	ClipGuide	18
INPUT SUBMENU	12	Mode	18
PICTURE SUBMENU	12	Display Type	18
COLOR SUBMENU	13	Y Limits	19
<i>Color Matrix</i>	13	C Limits	19
<i>Color Temperature Presets</i>	13	USER ASSIGN SUBMENU	19
<i>RGB Bias and Gain</i>	13	REMOTE SUBMENU	20
SCREEN SUBMENU	14	SDI STATUS SUBMENU	20
<i>Scan</i>	14	SETUP SUBMENU	21
<i>Aspect Ratio Setting</i>	14	Format Display	21
<i>Mono / Color</i>	14	TimeCode	21
<i>H/V Delay</i>	14	Power Save	21
<i>Shift H</i>	14	Key Lock	21
<i>Shift V</i>	15	Reset to MFG Default	21
MARKER CONFIGURATION SUBMENU	15	Backup User Configuration	21
<i>Markers</i>	15	Restore User Configuration	21
<i>Center Marker</i>	15	Specifications	22
<i>Aspect Markers</i>	15	Maintenance / Color Calibration / Upgrade Procedure	23
<i>Safety Marker</i>	15	Screen Cleaning	23
<i>Marker Mat</i>	15	Faceplate Dusting	23
<i>Line Thickness</i>	15	Color Calibration	23
<i>Line Type</i>	15	Upgrading Orchid Firmware	23
AUDIO CONFIGURATION SUBMENU	16	Warranty Information	24
<i>Level Meter</i>	16		
<i>Meter Background</i>	16		
<i>Display Channels</i>	16		
<i>Active Channel Only</i>	16		

Product Overview

The **Orchid OR-701A** is a 3-RU Full Featured rack mount Audio / Video monitor system. With built-in Waveform Monitor, Vector scope, Audio Bars, Stereo full range speakers, multiple audio outputs and several diagnostic tools, this monitor is ideal for use in control rooms, media duplication facilities and remote vans where monitoring the technical aspects of the feed is as important as a high definition image. The OR-701A provides a complete Audio, Video monitoring solution for 2 HD/SD-SDI feeds. The OR-701A is equipped with two HD/SD-SDI inputs with an active switched loop thru as well as optional input slot which can be used for an additional Component, DVI-I or other input formats. Diagnostic tools include our exclusive ClipGuide™ feature, 16 Tri-Color Audio Bar Graph meters with peak hold and numeric display of headroom and peak levels, as well as real time analysis of color space conversion Gamut Errors. Other standard features include factory calibrated screens, easy to navigate on screen menus with 5 button control, 11 assignable function keys, 4 assignable rotary encoders, adjustable color temperature, aspect ratio settings, a variety of screen markers, under scan mode, blue-only mode, monochrome mode, H/V delay, 7 assignable GPI inputs.....

Features

High Resolution 7" Widescreen Panel

The OR-701A features an all-digital TFT-MegaPixel active matrix LCD system. The LCD panel features a nominal brightness of 350 cd/m² and a contrast ratio of 400:1 making the display ideal in a variety of environments and lighting conditions.

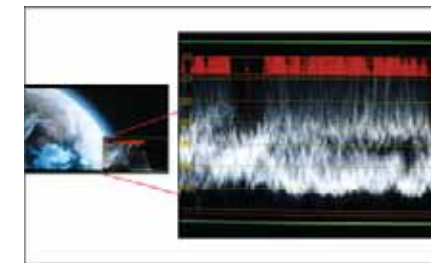

Waveform monitor function

The built-in waveform monitor (which includes adjustable White and Black clip level indicators) can be displayed in various aspect ratios, positions, and transparency options. The Waveform Monitor not only monitors luminance, but can also warn the user for out-of-range conditions such as overexposure or "blacker-than-black" errors with fully user-adjustable warning limits.



Real-time Color Vectorscope

The built-in Vectorscope allows users to monitor color gamut range in real time. It displays in full color and can also be displayed in various sizes, positions, and transparency options. The Vectorscope has adjustable gain from 1x to 5x.



ClipGuide™

The ClipGuide function operates with both the Waveform display and Monochrome/Color picture display. Both the upper and lower ClipGuide levels are user-adjustable in order to accurately display over-and-under exposures during different shooting conditions. For example, the upper ClipGuide limit may be set to 85 IRE and the lower limit to 10 IRE. With these settings, any exposures over the set limit of 85 IRE will display red on both the Waveform and picture (if selected). The same will be true for blacks under 10 IRE.

Chroma monitor function

Included in the ClipGuide menu are settings for monitoring color gamut errors, which can occur in color space conversion. Any data exceeding these values will be displayed as Yellow in the picture. The factory preset for C limits are 16 and 240 according to ITU-R BT.709. Typically, these values should not be exceeded during normal video production.



Precision Audio Level Meters

De-embeds and displays up to 16 channels of audio using sixteen 64-segment tri-color Audio Meters with user-adjustable reference levels. The Audio Level Meters provide numerical indicators and headroom levels, as well as peak hold function. Audio Channel Loss Warning prevents errors during monitoring.

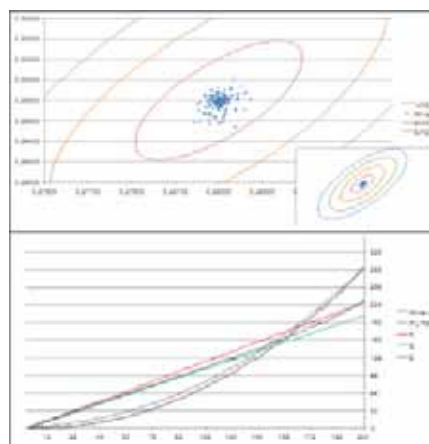

Precision White Balance with Color Temperature Adjustment

White balance adjustment is essential in order to render colors correctly. To display colors correctly, gray scale should maintain identical color temperature. The white balance for ORCHID monitors defaults to D65 (6500K) so the user does not need to adjust white balance. LCD monitors have color-matching issues because white balance can be affected by a change in luminance level. Our unique color management system solves this problem.

The ORCHID operating system includes an Automatic White Balance function that allows a "One Button" calibration procedure when used with a Minolta CA-210 color probe. All Orchid Series LCD panels are calibrated at the factory to ensure color conformity between screens.

Select color temperature and gamma mode

Color temperature presets may be selected between D65 or D93 as well as user-defined settings. Gamma settings are adjustable from 1.0 to 3.0 in 0.1 steps. The standard setting is 2.2.

Flexible Screen Markers

A variety of screen markers in 4:3, 16:9, and full screen modes allow accurate monitoring of the different aspect ratios used in broadcast environments.

User-Definable Function Buttons

Eleven user-definable function buttons and four Rotary Encoders on the front panel allow quick access to numerous settings and features including Input 1, Option Input, Waveform, Vectorscope, Audio Bars, aspect ratio, screen markers, monochrome mode, H/V delay mode, and more.

AUDIO Jack

There are 2 front panel Headphone jacks, one full sized 1/4" and one 3.5mm. On the rear panel there is a stereo, +4 line output using 3-pin XLR connectors and a 3.5mm -10 unbalanced jack to feed an external amplifier. It is possible to utilize both the front panel Headphone Connectors and rear panel line output connectors simultaneously with individual volume controls

Installation and Initial Setup

Unpacking

Carefully unpack the OR-701A monitor and verify that the following items are included:

- OR-701A Monitor
- 12V 4.6A XLR Power Supply with 4-Pin Female XLR Connector
- Operating Instructions

Inspect the unit for any physical damage that may have occurred during shipping. Should there be any damage, immediately call Marshall Electronics Customer Service at (800) 800-6608. If you are not located within the continental United States, call +1 (310) 333-0606.

Mounting

The OR-701A monitor features standard 19" rack mount configuration with tilt capability. First secure the upper screws and then the lower ones.

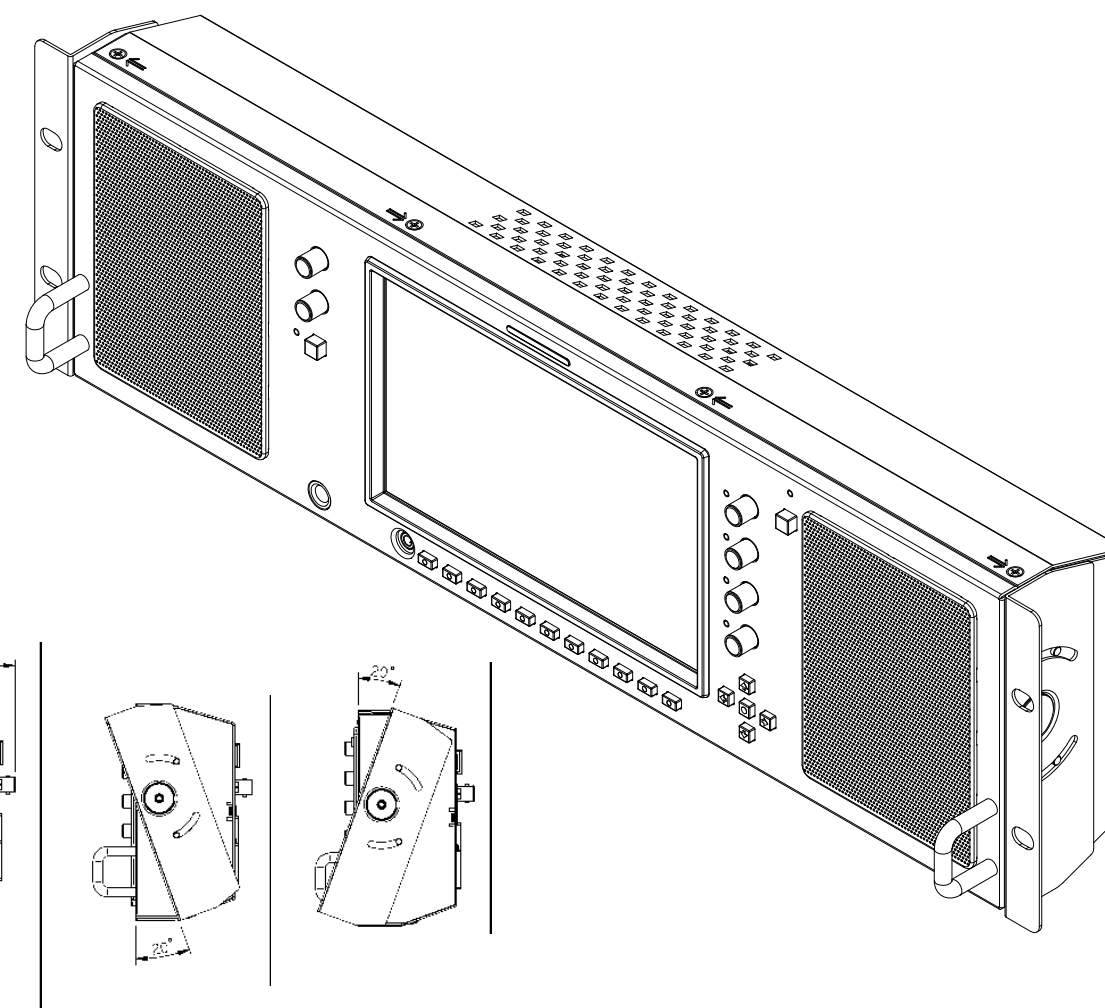

Connections and Power-On

Plug the power supply into an AC power source (100-240 V @ 50/60 Hz). Attach the 4-pin female XLR connector to the back of the monitor. The monitor will draw no more than 4.0 Amps at 12 Volts in operation (48 Watts).

Connect the required cables for the video signal input and output. Connect Audio Output cables (Power must be applied to the OR-701A for the active video loop-through outputs to be activated.) All BNC connectors are rated at 75Ω.

Front Panel Features

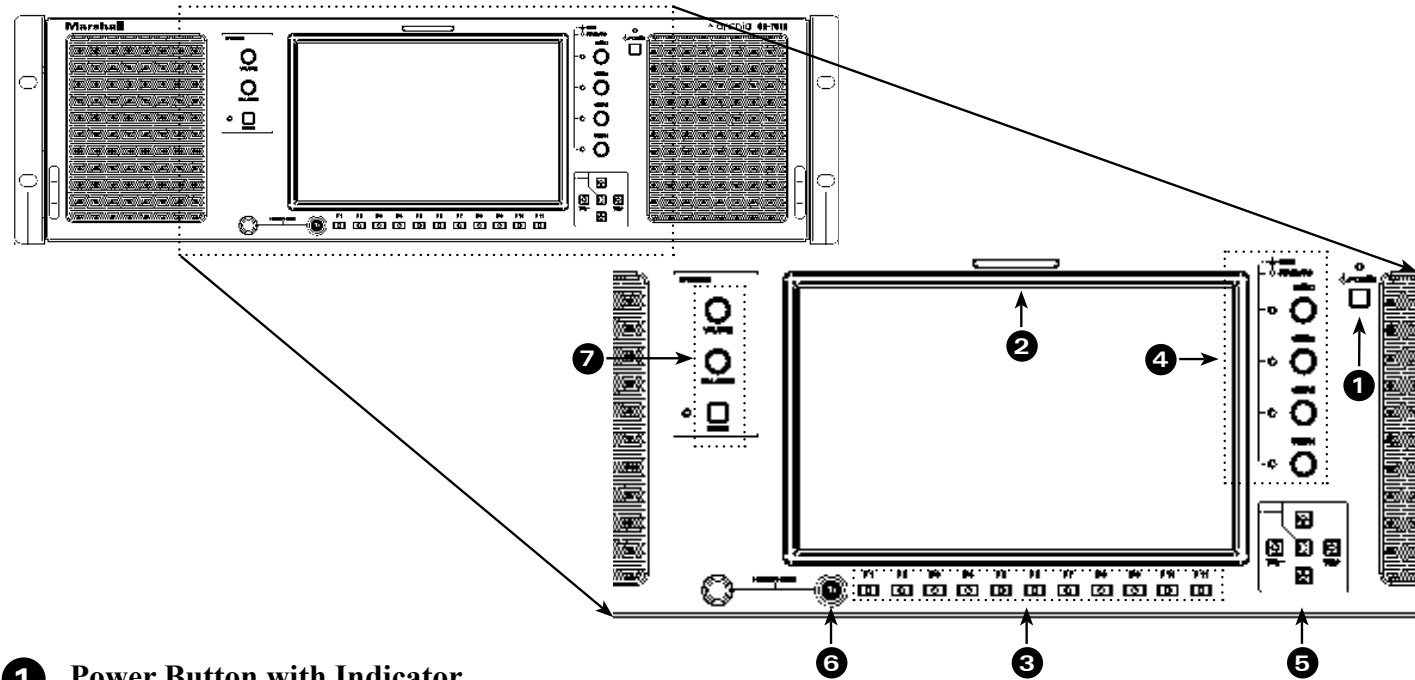

1 Power Button with Indicator

Press power switch to turn on the power the unit and indicator lights will turn on. Press again to turn off the power.

2 Tri-Color Tally Light

30mm Tri-Color tally lamp controlled via the Remote connector on the rear of the unit.

3 User-Definable Function Keys

Eleven user-definable function buttons can be used for direct access to various settings. Functions are assigned using the on-screen menu

4 User-Defined Rotary Encoders

Four Rotary Encoders may be assigned their function thru the User Assign menu. The Standard modes are;

- User 1 Brightness
- User 2 Contrast
- User 3 Saturation
- User 4 Sharpness

When pressed, the LED will illuminate, turning the encoder will allow the user to make adjustments to the selected value. When pressed again, the LED will turn OFF and the value will return to the preset level.

5 MENU and Volume Control Buttons

Press the Center MENU Button to access the on-screen Menu, Press the UP-↑, Down-↓, Left-←, or Right-→ Buttons to navigate the on-screen menu and change values. Press the Center Menu Button to save any changes or selections. Exit the on-screen menu by pressing the Left-← Button one or more times. When not in the Menu mode, the Left-←, or Right-→ Buttons control the Headphone Volume directly.

6 Headphone Jack

1/4" and 3.5mm stereo headphone jacks. Left and Right source are selected from the on-screen menu and are the same as for the built in speakers. Level for both headphone jacks are controlled via the left/right menu keys when not in menu mode. (Use of headphones will not mute front speakers.)

7 Front Speakers Controls

The top knob controls the volume of the front speakers. The center knob adjusts the balance between left and right front speakers. The push button at the bottom mutes the front speakers only. When muted the led indicator turns RED

- Insertion of a headphone plug into either the 1/4" or 3.5mm headphone jacks will not mute the front speakers.
- The Front speakers are not affected by the Audio Mute command found in the Function Preset menu.

Rear Panel Features

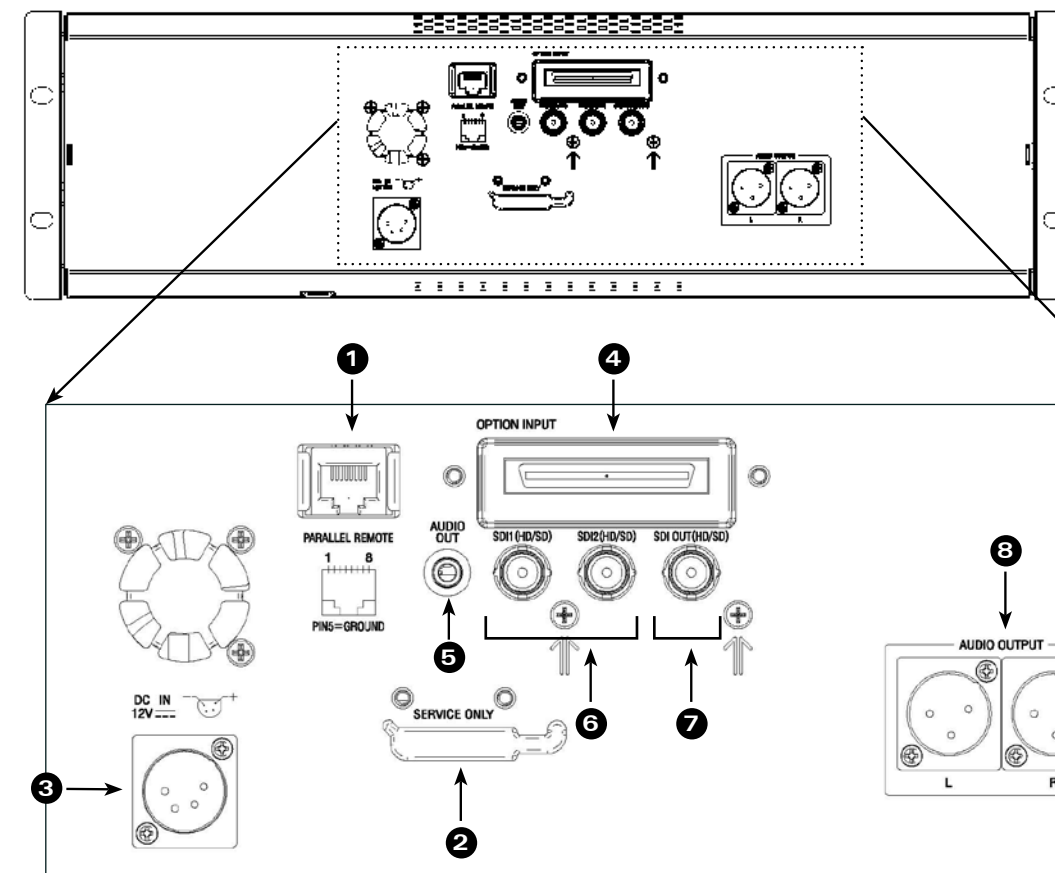

Parallel Remote RJ-45 Pin Assignments

Pin 1	GPI 1
Pin 2	GPI 2
Pin 3	GPI 3
Pin 4	GPI 4
Pin 5	GND
Pin 6	GPI 5
Pin 7	GPI 6
Pin 8	GPI 7

1 GPI Input

RJ-45 connector for 7 user-assignable GPI inputs. Assignable using the on-screen menu.

2 Service Port

Proprietary connection used for firmware upgrades and LCD color balance calibration. (Optional OR-SM Service Module Required)

3 Power Input

Connect 12VDC to the 4-Pin XLR power input connector. Power can be supplied from the included power supply, or from a variety of DC sources supplying at least 1 Amp at 12 Volts.

IMPORTANT: If using a power source other than the included power supply be sure that the polarity of the DC input is correct:

Pin 1: GND / Pin 2: N/C / Pin 3: N/C / Pin 4: +12VDC

4 Option Slot

Used to connect an optional input card such as the OR-DVI (DVI input) or OR-YPR (Component input).

5 Audio Output

3.5mm stereo Un-Balanced -10 dBu line level output for monitoring imbedded audio channels. The desired audio channels are selected in the Audio on screen menu. The output level is also controlled thru the Audio on screen menu.

6 Video input Connectors

Dual Auto-Sensing HDSDI BNC Video Inputs There are two HDSDI video inputs, each are video input auto detects HD and SD SDI video signals.

7 Video Output Connector

The output connector is an active re-clocked video signal from the Selected HDSDI input.

8 Balanced Audio Output Connectors

3 Pin Male XLR connectors for Left / Right +4dBu Line output to feed external amplifiers or other professional processing equipment.

OR-701A Compatible Formats

Format	HD/SD-SDI	Optional DVI Module	Optional Component Module
480 / 60i	✓		✓
576 / 50i	✓		✓
480 / 60p			✓
576 / 50p			✓
720 / 60p	✓		
720 / 50p	✓		
720 / 30p	✓		
720 / 25	✓		
720 / 24p	✓		
1080 / 60p			
1080 / 50p			
1080 / 60i (30PsF)	✓	✓	✓
1080 / 50i (25PsF)	✓	✓	✓
1080 / 48i (24Psf)	✓	✓	✓
1080 / 30p	✓		
1080 / 25p	✓		
1080 / 24p	✓		
VGA		✓	✓
SVGA		✓	✓
XGA		✓	✓
SXGA		✓	✓
UXGA		✓	✓
WUXGA			

On-Screen Menu

OR-701A MENU STRUCTURE OVERVIEW			
INFO	MODEL NAME	OR-701A	
	OPTION CARD	N/A	
	INPUT	SDI 1	
	INPUT FORMAT	1080i / 60	
	COLOR MATRIX	709	
	COLOR TEMP	D65	
	VERSION	1.2	
INPUT	RETURN		
	INPUT SELECT	SDI 1 / SDI 2 / Option	
	Analog Calibrate	>	
PICTURE	RETURN		
	BRIGHT	0~100 [50] is Calibrated setting	
	CONTRAST	0~100 [80] is Calibrated setting	
	SATURATION	0~100 [50] is Calibrated setting	
	SHARPNESS	0~100 [50] is Calibrated setting	
	GAMMA	1.0 to 3.0 in 0.1 steps [2.2] is Calibrated Setting	
COLOR	RETURN		
	COLOR MATRIX	AUTO, RGB, BT. 601, BT. 709	
	COLOR TEMP	CIE D65, JP D93, USER, CAL D65/D93, CAL D65, CAL D93	
	RED BIAS	-128 to 127 [0] is Calibrated Setting	
	GREEN BIAS	-128 to 127 [0] is Calibrated Setting	
	BLUE BIAS	-128 to 127 [0] is Calibrated Setting	
	RED GAIN	0.500 to 1.992 [x1.00] is Calibrated setting	
	GREEN GAIN	0.500 to 1.992 [x1.00] is Calibrated setting	
BLUE GAIN	0.500 to 1.992 [x1.00] is Calibrated setting		
SCREEN	RETURN		
	SCAN	NORMAL, OVERSCAN, ZOOM	
	ASPECT	AUTO, 4:3, 16:9	
	MONO COLOR	RGB	
		MONO	
		RED	
		GREEN	
		BLUE	
		R+G	
		R+B	
	G+B		
	H/V DELAY	ON / OFF	
	SHIFT H	-128 to 127 [0] is Calibrated Setting (- = Right)	
SHIFT V	-128 to 127 [0] is Calibrated Setting (- = Down)		
MARKER	RETURN		
	MARKER	ON / OFF	
	CENTER	ON / OFF	
	ASPECT RATIO	OFF	
		4:03	
		16 : 9	
		1.85 : 1	
		2.35 : 1	
		4 : 3 & 2.85 : 1	
	4 : 3 & 2.35 : 1		
	SAFETY ZONE	80% to 100% (OFF) [95%] is normal setting	
MARKER MAT	CLEAR, HALFTONE, BLACK		
LINE THICKNESS	1, 2, 3		
LINE LEVEL	GRAY, HALFTONE, WHITE, INVERT		

On-Screen Menu (continued)

OR-701A MENU STRUCTURE OVERVIEW			
AUDIO	RETURN		
	LEVEL METER	ON / OFF	
	METER BACKGROUND	ON / OFF	
	DISPLAY CHANNELS	1~16	
	ACTIVE CH ONLY	ACTIVE, ALL	
	METER COLUMNS	DUAL, QUAD	
	DISP TYPE	OVERLAP, OVERLAY	
	FRONT VOLUME	0 to 40	
	REAR VOLUME	0 to 40	
	HEADROOM START	-6 to -60 [-20] is SMPTE Standard	
	HEADROOM END	0 to -20 [-6] is Normal setting	
	LEFT CHANNEL	CHANNEL1 TO CHANNEL 16	
	RIGHT CHANNEL	CHANNEL1 TO CHANNEL 17	
	LOAD CH PRESET FROM >	PRESET 1 to PRESET 8	
	SAVE CH PRESET TO >	PRESET 1 to PRESET 9	
	CH PRESET	LOCK / UNLOCK	
WAVEFORM	RETURN		
	LAYOUT	NORMAL, LAYOUT A, LAYOUT B	
	WAVEFORM	ON / OFF	
	SIZE	SMALL, MEDIUM, LARGE	
	POSITION	LEFT TOP, LEFT BOTTOM, RIGHT TO, RIGHT BOTTOM	
	TYPE	OVERLAY / OVERLAP	
	Y OVER LIMIT	[100.0%] % IRE -7.3% to 109.1%	
	Y UNDER LIMIT	[100.0%] % IRE -7.3% to 109.1%	
VECTORSCOPE	RETURN		
	LAYOUT	NORMAL, LAYOUT A, LAYOUT B	
	VectorScope	ON / OFF	
	SIZE	SMALL, MEDIUM, LARGE	
	POSITION	LEFT TOP, LEFT BOTTOM, RIGHT TOP, RIGHT BOTTOM	
	GAIN	X1.00 to X1.91 in .01 steps	
ClipGuide	RETURN		
	ClipGuide	ON / OFF	
	MODE	LUMA (Y)	
		LUMA (Y) ON MONO	
		CHROMA (C)	
		CHROMA (C) ON MONO	
		Y & C	
	Y & C ON MONO		
	DISPLAY TYPE	ZEBRA / FILL	
	Y UPPER LIMIT	[100.0%] % IRE -7.3% to 109.1%	
Y LOWER LIMIT	[0.0%] % IRE -7.3% to 109.1%		
C UPPER LIMIT	0~255 [016 = 7.5 IRE, 235 = 100 IRE]		
C LOWER LIMIT	0~255 [016 = 7.5 IRE, 235 = 100 IRE]		
USER ASSIGN	RETURN		
	F-1 THRU F-5	INPUT 1	
		INPUT 2	
		INPUT 3	
		GAMMA 1.0	
		GAMMA 1.8	
		GAMMA 2.0	
		GAMMA 2.2	
		GAMMA 2.4	
		GAMMA 2.6	
		WHITEBALANCE D65	
		WHITEBALANCE D93	
		MONO	

On-Screen Menu (continued)

USER ASSIGN	F-1 THRU F-6	COLOR CHANNEL	
		SCAN	
		ASPECT	
		ZOOM	
		HV DELAY	
		MARKER	
		AUDIO METER	
		AUDIO PRESET 1	
		AUDIO PRESET 2	
		AUDIO PRESET 3	
		AUDIO PRESET 4	
		AUDIO PRESET 5	
		AUDIO PRESET 6	
		AUDIO PRESET 7	
	AUDIO PRESET 8		
	AUDIO MUTE		
	LAYOUT A		
	LAYOUT B		
	WAVEFORM MON		
	VECTORSCOPE		
CLIPGUIDE			
TIMECODE			
Rotary USER 1 to USER 4	BRIGHT		
	CONTRAST		
	SATURATION		
	SHARPNESS		
REMOTE	RETURN		
	PIN 1 THRU 8 (Pin 5 is Ground)	INPUT 1	AUDIO METER
		INPUT 2	AUDIO PRESET 1
		INPUT 3	AUDIO PRESET 2
		GAMMA 1.0	AUDIO PRESET 3
		GAMMA 1.8	AUDIO PRESET 4
		GAMMA 2.0	AUDIO PRESET 5
		GAMMA 2.2	AUDIO PRESET 6
		GAMMA 2.4	AUDIO PRESET 7
		GAMMA 2.6	AUDIO PRESET 8
		WHITEBLANCE D65	AUDIO MUTE
		WHITEBALANCE D93	LAYOUT A
		MONO	LAYOUT B
		SCAN	WAVEFORM MON
ASPECT		VECTORSCOPE	
ZOOM	CLIPGUIDE		
HV DELAY	TIMECODE LTC		
RED ONLY	TIMECODE VITC 1		
BLUE ONLY	TIMECODE VITC 2		
GREEN ONLY			
MARKER			

On-Screen Menu (continued)

REMOTE	PIN 1 THRU 8 (Pin 5 is Ground)	R TALLY
		G TALLY
		B TALLY
		LEFT R TALLY
		LEFT G TALLY
		LEFT B TALLY
		RIGHT R TALLY
		RIGHT G TALLY
RIGHT B TALLY		
SDI STATUS	RETURN	
	ERROR COUNT	0 - 9999
	RESET COUNTER	
	DISPLAY	OFF / ON / AUTO
SETUP	RETURN	
	FORMAT DISP	AUTO / ON / OFF
	TIMECODE	OFF / LITC / VITC1 / VITC2
	POWER SAVE	ALWAYS ON
		2 MIN
		5 MIN
		10 MIN
		30 MIN
		1 HOUR
	2 HOUR	
	KEY LOCK	LOCK / UNLOCK
	PICTURE DELAY	NORMAL / FAST / FASTEST
	RESET TO MFG DEFAULT >	REST NOW / CANCEL
	BACKUP USER CONFIG >	BACKUP NOW / CANCEL
	RESTORE USER CONFIG	RESTORE NOW / CANCEL

Main Menu and Navigation

Access the main menu by pushing the **MENU** button on the front panel of the monitor.



- Step through menu items by pressing the **↑**, **↓**, **←** and **→** buttons.
- Choose a submenu or select a menu item by pushing the center **MENU** button.
- Return to the previous menu by pressing the **←** button.
- Exit the main menu by again pressing the **←** button.

INFO SUBMENU

The INFO Submenu is a read-only display that gives the user information about the particular screen being viewed. No adjustment can be made from this submenu.



INPUT SUBMENU

The Input sub menu allows the user to select either the SDI-1 SDI-2 inputs or the Optional Input module if installed as the source to be displayed.

PICTURE SUBMENU

The Picture submenu allows the user to make adjustments to Brightness, Contrast, Saturation, Sharpness and Gamma using the Joystick control.

Brightness

- Varies between 0 and 100 (50 is standard).
- 50 is default value with standard black level.
- Increasing brightness level allows user to see BTB (Blacker-than-Black).

Contrast

- Varies between 0 and 100 (80 is standard).
- 80 is default value with 100% gain of video signal.

Saturation

- Varies between 0 and 100 (50 is standard).
- 50 is default value with nominal color saturation.
- Setting to 0 should display as monochrome.
- Increasing value will increase color saturation.

Sharpness

- Varies between 0 and 100 (0 is standard).
- 0 is default value with no scaling artifact.

Gamma

- Varies between 1.0 and 3.0 with 0.1 steps.
- If White Balance is set to User Mode, changing gamma will have no effect.



COLOR SUBMENU

The Color submenu allows the user to access to the Color management controls.

Color Matrix

Auto

- System automatically selects correct matrix.
- Typically, 601 for SD Formats, 709 for HD Formats.

RGB

- User can manually set to RGB.
- RGB should be used with GBR422 systems.

601

- Conforms to ITU-R BT.601 matrix.

709

- Conforms to ITU-R BT.709 matrix.

Color Temp

Use this setting to choose between color temperature presets:

- D65 (6500K). Conforms to CIE D65 White Point. $x = 0.3127$, $y = 0.3290$
- D93 (9300K). Conforms to Japanese D93 White Point. $x = 0.2830$, $y = 0.2980$
- USER (Adjustable Color Bias and Gain)
- CAL D65/D93 Use this to perform "One Button Color Calibration of both D-65 and D-93 LUTs using the optional OR-SM and Minolta CA-210 color probe.
- CAL D65 Use this to perform "One Button Color Calibration of D-65 LUT using the optional OR-SM and Minolta CA-210 color probe.
- CAL D93 Use this to perform "One Button Color Calibration of D-93 LUT using the optional OR-SM and Minolta CA-210 color probe.

RGB Bias and Gain

Select this submenu to fine-tune the monitor's color balance (R, G, B). This should only be done by someone experienced with video engineering, as this will alter the overall color shading of the screen. The purpose is to allow color matching to other types of monitors and/or displays. Note: The Color Temperature preset will automatically switch to CUSTOM when Color Bias or Gain settings are adjusted. It is normal for color bias adjustments to be very subtle. When selecting the RGB Bias and Gain submenus, changes to Gain and Bias will be seen in real time. Once the proper level is achieved the user must save this setting by pressing the Joystick. If the user leaves the setting menu before saving the value will return to the original setting.

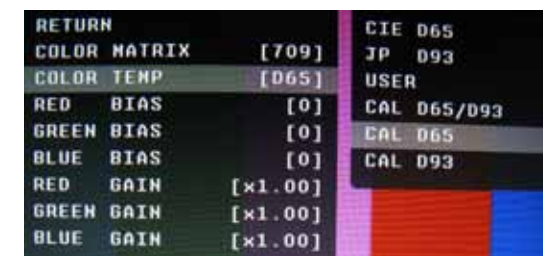



SCREEN SUBMENU

Scan

Normal (Zero Scan)

- Whole picture should be visible without any cropping.
- When in normal mode, it should not see non-active areas such as SAV, EAV.

Over (End-User TV Production Scan)

- 5% of the picture is cropped and zoomed to fill the screen.
- After cropping, it will maintain correct aspect ratio and center.

Zoom

- When in zoom mode, the center portion of the picture is magnified to fill the screen by approximately 4x.

Aspect Ratio Settings

Use to switch between Full Screen, 4:3 and 16:9 aspect ratios.

As the OR-701A monitor has a native resolution of 800 x 480 RGB pixels, incoming images are automatically scaled to fit the screen:

- In Auto mode, images are displayed in their native Aspect Ratio. SD is normally 4:3 / HD normally 16:9.
- In 4:3 mode, images are scaled to fill the maximum 4:3 portion of the screen (640 x 480), with black bars filling the remainder of the screen, regardless of its original format.
- In 16:9 mode, images are scaled to fill the maximum 16:9 portion of the screen (800 x 480) regardless of its original format.



AUTO with 16:9 source

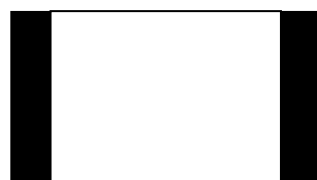

4:3 Mode with 16:9 source or native 4:3 in AUTO mode.



16:9 with 4:3 source

Mono / Color

Use the Mono / Color modes for monitor calibration or to analyze individual color components of an image.

- RGB = displays all three colors (Normal display)
- Mono = displays as monochrome.
- Red Channel = displays red channel only.
- Green Channel = displays green channel only
- Blue Channel = displays blue channel only
- R+G = Red + Green
- R+B = Red + Blue
- G+B = Green + Blue

H/V Delay

Use this setting to enable H & V Delay

- In H & V Delay mode, both horizontal sync and vertical sync are delayed, resulting in both horizontal and vertical blanking periods being shown at the center of the screen.

Shift H

Use the Up-↑ and Down-↓ menu buttons to change the value of this setting will shift the picture Horizontally. Negative values will move the picture Right, while Positive values will move the picture Left. [0] is center value.

Shift V

Use the Up-↑ and Down-↓ menu buttons to change the value of this setting, which will shift the picture Vertically. Negative values will move the picture DOWN, while Positive values will move the picture UP.

MARKER CONFIGURATION SUBMENU

Marker

Use this setting to enable or disable all on-screen markers. This setting affects the Center marker, Aspect markers, and Safety marker.

Center Marker

Use this setting to display a center marker on the screen.

Aspect Markers

Use these settings to superimpose one of 6 markers on the screen when in 16:9 mode.

- 4:3
- 16:9
- 1.85:1
- 2.35:1
- 4:3 and 1.85:1
- 4:3 and 2.35:1

Safety Marker

Use this setting to adjust the safety marker from 80% to 100% (Off) in 1% steps.

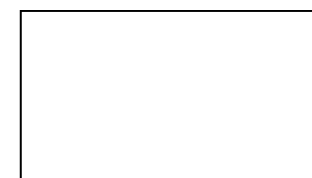

OFF (No Marker)

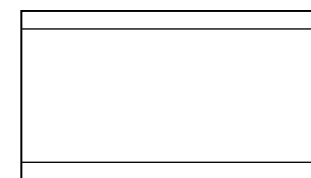

2.35:1 Aspect Ratio

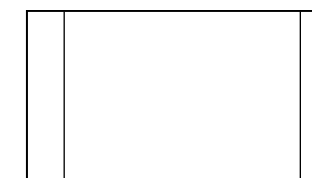

4:3 Aspect Ratio Marker

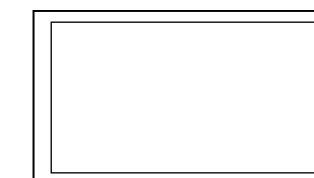

90% Safe Area

Marker Mat

Use this setting to change the format of the marker curtains between Clear, Halftone, or Black.

Line Thickness

Use this setting to choose the line thickness of the markers from 1, 2, or 3 pixels thick.

Line Type

Use this setting to select the style of line used for markers between White, Halftone, and Invert.

Example (80% Marker in 4:3 Mode):

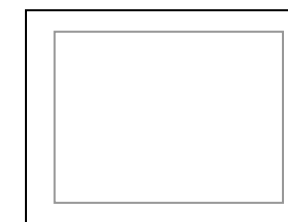

Normal Background



Black Background



AUDIO CONFIGURATION SUBMENU

■ Level Meter

Selects whether or not to display audio level meters.

■ Meter Background

Selects whether or not to display meter background.

■ Display Channels

Selects how many audio meters you want to display. You may select any number of channels from 1 to 16.

■ Active Channel Only

Allows a choice of All channels or Active channels only. Selecting Active will override the Display Channels setting.

■ Meter Columns

Allows a choice of displaying Level Meters is Dual (2) or Quad (4) columns.

■ Display Type

Allows a choice between Overlap and Overlay modes. Overlap is opaque and will block part of the video image where the Level Meters appear. Overlay is Halftone (semi-transparent) so video can be seen through the Level Meters.

■ Front Volume

Adjusts Headphone volume on the front panel. This value is adjustable from 0 to 40. Setting to 0 will Mute the output.

■ Rear Volume

Adjusts the Line Output jack on the rear panel. This value is adjustable from 0 to 40. Setting to 0 will Mute the output.

■ Headroom Start

Adjusts the point at which the level meters will change color from Green to Yellow. This is normally the level used for alignment. For digital audio in the US, the SMPTE standard is -20dBFS = 0VU = +4dBu. The European EBU standard is -18dBFS = 0VU. Other Alignment standards can be set using this menu.

■ Headroom End

Adjusts the point at which the level meters will change color from Yellow to Red. There is no official standard to where this point should occur. This is an arbitrary setting to give visual warning that the program level is peaking near the 0dBFS point at which there are no more bits and clipping will occur.

■ Left Channel / Right Channel

These menus are used to designate which one of the available 16 audio channels will be assigned to either the Left, Right, or both outputs for listening. For example, the user can choose to send CH 1 to the left output and CH 2 to the Right output, or the user can assign CH 1 to both Left and Right for a mono feed.

■ Load CH Preset From >

Use this menu to recall one of the 8 possible memory locations where the user previously stored channel output assignments. Use of this Load command will override the current channel output assignments.

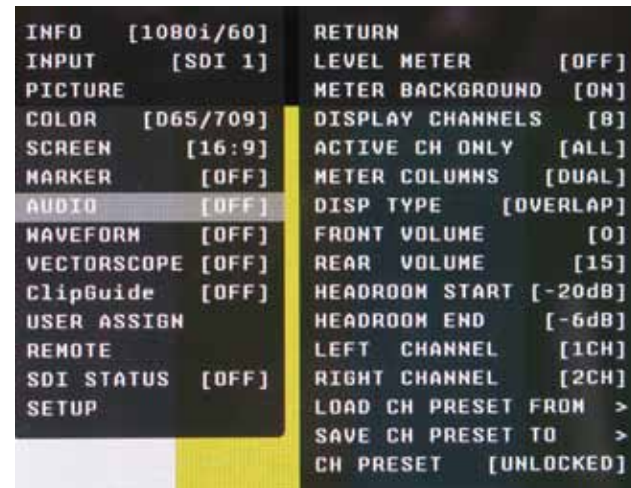

■ Save CH Preset To >

Use this menu to select which one of 8 memory locations where the user wants to store the current channel output assignments.

■ CH Preset

Use this menu to Lock or Unlock the ability to save to the Ch Preset memory locations. This helps to prevent accidental overwriting of stored presets. When Locked, Ch Presets may still be recalled.

WAVEFORM SUBMENU

■ Layout

Use this menu to choose from several available preset screen layouts. Choosing any of the available preset layouts will override the settings in the Waveform, Size and Position menus.

■ Waveform

Use this menu to turn the Waveform display On or Off when in the Normal mode.

■ Size

Use this menu to choose the size of the Waveform display in Normal mode. Choices are Small, Medium, and Large.

■ Position

Use this menu to select the position you want the Waveform display to occupy on the screen when in the Normal mode. Choices are Left Top, Left Bottom, Right Top, and Right Bottom.

■ Display Type

Use this menu to choose how to display the waveform. The choices are Overlay or Overlap. In the Overlay mode, the waveform will be semi-transparent and the user will be able to see the source video through the waveform. In the Overlap mode, the waveform will be Opaque and will block the source video.

■ Y Over Limit

Use this menu to set where you want the waveform to display Red when the video source exceeds the limit set. This value is adjustable from -7.3% to 109.1% IRE. This setting is shared with the ClipGuide Menu.

■ Y Under Limit

Use this menu to set where you want the waveform to display Red when the video source below the limit set. This value is adjustable from -7.3% to 109.1% IRE. This setting is shared with the ClipGuide Menu.

Limits

- Internally, Y values ranges from 0 to 255.
- -7.3 IRE is equal to 0 in digital.
- 0 IRE is equal to 16 in digital.
- 100 IRE is equal to 235 in digital.
- 109.1 IRE is equal to 255 in digital



VECTORSCOPE SUBMENU



Layout

Use this menu to choose from several available preset screen layouts. Choosing any of the available preset layouts will override the settings in the Vectorscope, Size, and Position menus.

Vectorscope

Use this menu to turn the Vectorscope display On or Off when in the Normal mode.

Size

Use this menu to choose the size of the Vectorscope display in Normal mode. Choices are Small, Medium, and Large.

Position

Use this menu to select the position you want the Vectorscope display to occupy on the screen when in the Normal mode. Choices are Left Top, Left Bottom, Right Top, and Right Bottom.

Display Type

Use this menu to choose how to display the Vectorscope. The choices are Overlay or Overlap. In the Overlay mode, the Vectorscope will be semi-transparent and the user will be able to see the source video through the Vectorscope. In the Overlap mode, the Vectorscope will be Opaque and will block the source video.

Gain

Use this menu to change the gain of the Vectorscope display. Normally, the Vectorscope displays x1.00. In order to allow a magnified view, the gain is adjustable from x1.00 to x4.98 in .01 steps. Changing this value has no effect on the source material.

ClipGuide SUBMENU



ClipGuide

Use this menu to turn the ClipGuide™ function On or Off.

Mode

Allows the choice of which ClipGuide function you want to display. There are 6 modes to choose from:

- Luma (Y) displayed over Color video
- Luma (Y) displayed over Mono video
- Chroma (C) displayed over Color video
- Chroma (C) displayed over Mono video
- Luma (Y) and Chroma (C) displayed over Color Video
- Luma (Y) and Chroma (C) displayed over Mono Video

Display Type

ClipGuide will display over and under values in two ways when monitoring the video signal. In the Zebra mode, over and under conditions are indicated in a Zebra (diagonal stripe) pattern. In the Fill mode, over and under conditions are indicated by a solid fill. In either Zebra or Fill mode, Red is the indication for Luma and Yellow is the indication for Chroma.

Y Limits (These values are shared with WFM settings)

Set luminance upper and lower limits to be monitored.

- Limits are displayed in IRE unit
- Varies between -7.3 IRE and 109.1 IRE
- This value will be shown in WFM window as red line
- Any data exceeding these values will be displayed as red on the picture
- These values are shared with WFM settings
- Internally, Y values ranges from 0 to 255
- -7.3 IRE equals to 0 in digital.
- 0 IRE equals to 16 in digital.
- 100 IRE equals to 235 in digital.
- 109.1 IRE equals to 255 in digital

C Limits

Sets the chrominance levels to be monitored.

- Displayed in 8-bit digital video representation.
- Any data exceeding these values will be displayed as Yellow in the picture
- The factory preset for C limits are 16 and 240 according to ITU-R BT.709
- Typically these values should not be exceeded during normal video production

USER ASSIGN SUBMENU

F-1 thru F-11

There are eleven Function Keys and Four Rotary Encoders on the front panel of the OR-702. Each of these F-keys key may be assigned any one of 31 different functions as required by the job or individual user. The Rotary Encoders may be assigned in the same manner. These functions are listed in the Menu Overview section of this manual.



One-way functions

- Pressing pre-defined key will activate the feature
- When it is enabled, the indicator of the key will be lit up.
- Pressing again will have no effect.
FOR EXAMPLE: Selecting Input, Selecting Audio Preset, Selecting White Balance

Two-way functions

- Pressing pre-defined key will active the feature
- When it is enabled, the indicator of the key will turn on
- Pressing again will deactivate the feature.
FOR EXAMPLE: Scan, WFM, ALM, Layout, HV Delay

Sequential functions

- Pressing pre-defined key will rotate features in sequence.
FOR EXAMPLE: Timecode, Color Channel
- TimeCode will change its state for OFF->LTC->VITC1->VITC2->OFF
- Color Channel will change its state for RGB->R Only->G Only ... -> RGB

REMOTE SUBMENU

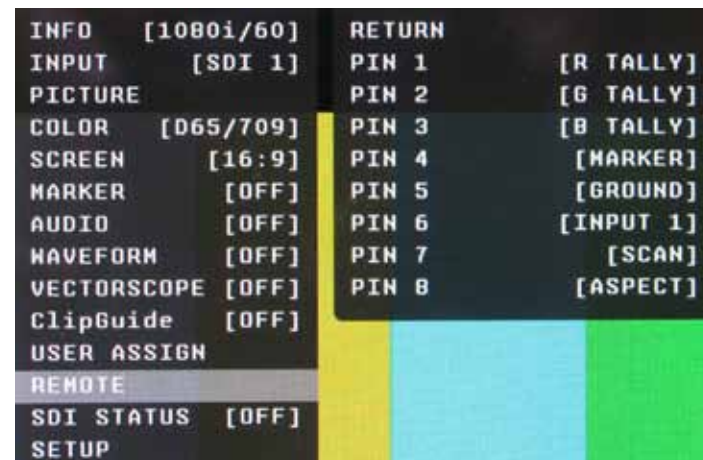

■ Pin 1 through Pin 8

The RJ-45 Remote connector on the rear panel has 8 pins. Pin 5 is Ground, while the remaining 7 pins are pulled high to 3.3VDC and may be used for Tally or other Remote Commands. A list of available Commands and Tally configurations can be found in the Menu Overview section of this manual. The command or Tally is activated by connecting the corresponding Pin (1-4 and 6-8) to Pin 5 (Ground).

Event Trigger

- Two types of events are allowed.
- The falling event is when you pull down to ground, and the rising event is when you remove the ground and the pin returns to normal high state.
- Falling events occurs only once and on the event of power up sequence.
- This means a falling event will occur only once regardless of whether its pin is repeatedly grounded such as when selecting an input source.
- The rising event can only occur once a pin has been pulled down to ground to activate the command such as turning on a tally releasing ground (open circuit) to turn off.
- Priority
- Lower pin number has higher priorities over higher pin numbers during power up sequence.

Tally System

Tally System can be used with non-separated mode and separated mode.

Non-separated mode

- Supports R/G/B tallies.
- Can mix any channels. FOR EXAMPLE: Mix Red and Green for Amber.
- Cannot mix R/G/B for White (It will be pink due to white balance).
- Cannot be assigned with separated tallies.

Left/Right Separated Mode

- Supports R/G/B tallies on each Left and Right.
- Can mix any channels for each Left and Right.
- Cannot mix R/G/B for White (It will be pink due to white balance).
- Cannot be assigned with non-separated tallies.

SDI STATUS SUBMENU

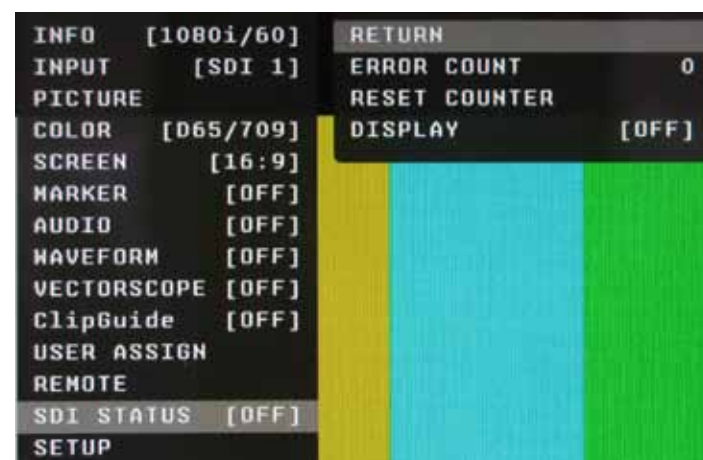

The SDI submenu shows the SDI Error Count, Allows you to Reset the counter and sets up how you would like to display the SDI Error counter. The Choices are OFF – ON – AUTO.

The SDI Error Counter will count the following types of errors.

- Line-based CRC error
- Line number error
- TRS error
- EDH CRC error
- ANC data checksum error

An error count of more than 1 could be considered as abnormal. There is no particular scale to the number of errors counted. The max number of errors displayed is 9999. For example assume that there is a problem with a source and it is outputting a SDI signal with invalid CRC for each line. The Orchid Error counter will result in a count of 9999 within 9 frames (150ms). However, if the source is not bad and the Error counter occasionally counts up these are mostly caused by poor connections or bad SDI cables.

SETUP SUBMENU

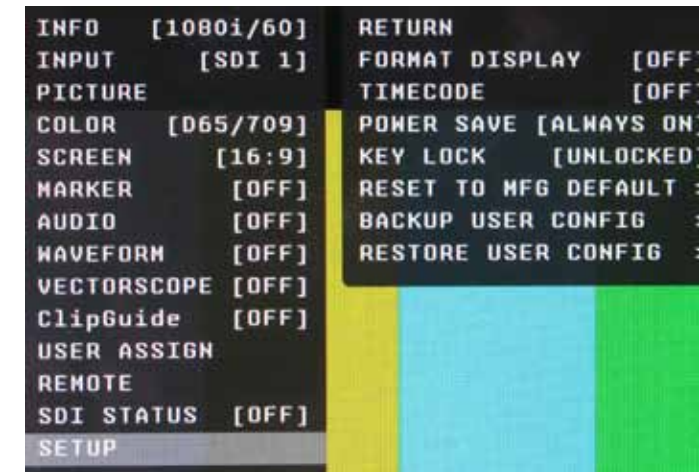

■ Format Display

Auto

This mode will display the video format information for about 8 seconds whenever video format is changed.

Off - This mode will not display any video format information.

On - This mode will always display current video format information.

■ TimeCode

Selects among to following options: OFF / LTC / VITC1 / VITC2. In the most cases, the value of LTC and VITC1 will be identical to each other.

■ Power Save

- When enabled, the monitor will go to sleep after a predefined time has passed when loss of picture occurs.
- When a valid video format is detected, the monitor will wake up from the sleep state.
- Pressing any front panel keys will wake up the monitor.
- In the sleep state, all lights (including the backlight and front key indicators) are turned off.
- Any change in parallel remote status will wake up the monitor.
- Tally status is not affected by sleep mode.

■ Key Lock

When it is locked, user cannot use front panel keys except for accessing the menu.

■ Reset to MFG Default

- This will Restore all configuration values and functions to the factory preset state.
- This will not change Model Name, Serial Number, or White Balance Data.
- Requires Confirm action by selecting Confirm again.
(Select Reset -> Press Enter -> Select Confirm -> Press Enter)
- Resetting default will not effect backed up data.

■ Backup User Configuration

- This command backs up all user information to secondary EEPROM (User settings)
- Requires Confirm action by selecting Confirm again.
(Select Backup -> Press Enter -> Select Confirm -> Press Enter)

■ Restore User Configuration

This will Restore all information previously stored to the secondary EEPROM (User settings) and overwrites all Current settings. Requires Confirm action by selecting Confirm again. (Select Restore -> Press Enter -> Select Confirm -> Press Enter). After restoration, the system exits the OSD menu.

Specifications

Front

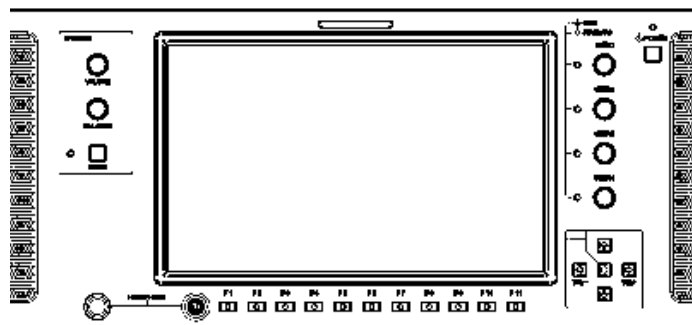

Rear

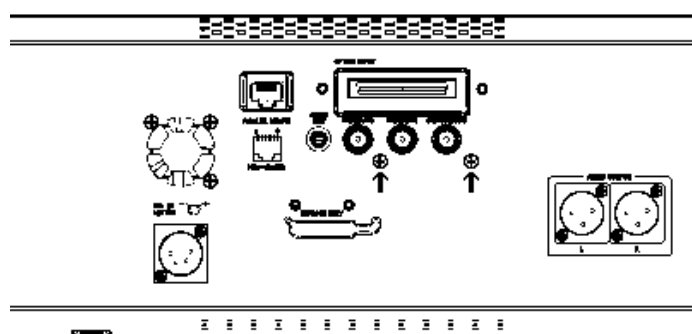

Dimensions

UNIT (inches)

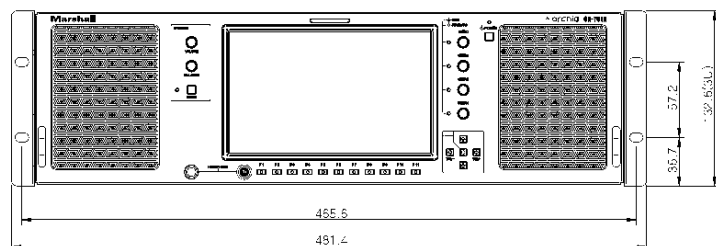
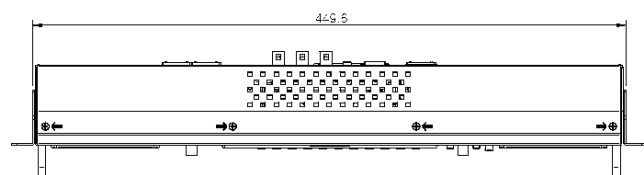
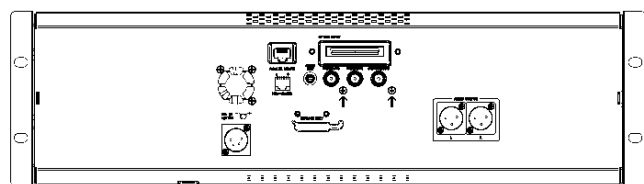

■ PANEL

Screen Size	7" Diagonal
Display Area (h x v)	6" x 3.6"
Aspect Ratio	16:10 (16:9 / 4:3 Selectable)
Pixels	800 x 480
Color Depth	8-bit (16.7M Colors)
Viewing Angle (h x v)	-55°~+65° x -40° ~+50° (CR >10)
Brightness	350 cd/m ²
Contrast Ratio	400:1
Pixel Pitch (h x v)	0.1905 x 0.1905 mm

■ VIDEO INPUT/OUTPUT

HD/SD-SDI Video Input / Output

■ AUDIO INPUT/OUTPUT

Up to 16 channels of audio de-embedded from the SDI signal

Dual Headphone outputs on Front Panel

3.5mm -10dBu Un-Balanced output on rear panel

Stereo 3-pin XLR Balanced +4dBu Line Output on rear panel

■ CONNECTORS

Video Input - 2 x BNC Female (75 Ω)

Video Output (Active Loop-Through) - 1 x BNC Female (75 Ω)

Parallel Remote - RJ-45

Optional Input Slot

Audio Output Jacks:

Front 3.5mm Stereo Headphone

Front 1/4" Stereo Headphone

Rear XLR Bal +4 Stereo Line Output

Rear 3.5mm -10 Un-Balanced Line Output

Service Terminal

Power Input: 4-Pin Male XLR

Pin 1: GND

Pin 2: N/C

Pin 3: N/C

Pin 4: +12VDC

■ ELECTRICAL

Power Consumption - 2 Amp (Max) @ 12VDC (24W Max)

Voltage Requirement - 12VDC (10VDC-18VDC)

■ MECHANICAL

Dimensions (w x h x d)	18.9" x 5.2" x 2.4"
Weight (Monitor Only)	6 lbs including power adapter
Operating Temperature	32° F to 104° F (0° C to 40° C)
Storage Temperature	-4° F to 104° F (-20° C to 40° C)
RoHs	Do not dispose. Return to Manufacturer or Authorized Recycle Facility.

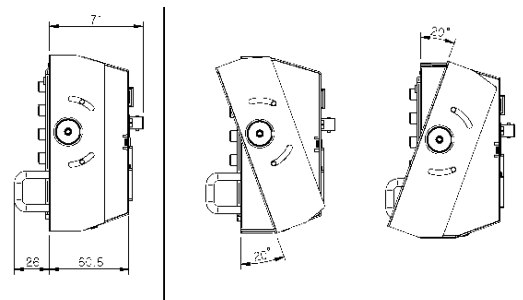

Maintenance / Color Calibration / Upgrade Procedure

■ Screen Cleaning

Periodically clean the screen surface using ammonia-free cleaning wipes (Marshall Part No. V-HWP-K). A clean micro-fiber cloth can also be used using only non-abrasive and ammonia-free cleaning agents. Do not use paper towels. Paper towel fibers are coarse and may scratch the surface of the polycarbonate faceplate or leave streaks on the surface. Antistatic and fingerprint resistant cleaning agents are recommended. Do not apply excessive pressure to the screen to avoid damaging the LCD.

■ Faceplate Dusting

Dust the unit with a soft, damp cloth or chamois. Dry or abrasive cloths may cause electrostatic charge on the surface, attracting dust particles. Neutralize static electricity effects by using the recommended cleaning and polishing practice.

■ Color Calibration Procedure

*** In order to perform color calibration an optional OR-SM Service Module is required. ***

- Allow both the unit you want to calibrate and the Minolta® CA-210 to warm up for a minimum of 20 minutes.
- Attach the CA-210 color probe to the update dongle.
- With the unit still turned on, insert the update dongle into the service port at the rear of the screen you wish to calibrate.

• Use the menu navigation joystick or menu buttons of the appropriate screen and go to:

Color Menu Color Temp

- Cal D65/D93 to calibrate both
- Cal D65 to calibrate only D65
- Cal D93 to calibrate only D93

Press enter once to select and again to confirm

- Follow the on-screen instructions

Notes:

1. If there is no color probe attached or you make a mistake and try to calibrate the incorrect screen, you will get an error message and the screen will default to previous settings.
2. If the calibration process is interrupted while in progress, the current screen settings will be corrupted and the calibration process will have to be repeated.

■ Upgrading Orchid Firmware

*** In order to install new firmware an optional OR-SM Service Module is required. ***

Procedure:

1. Download the Orchid update software package from the Marshall web site
2. Unzip the included files from the zip folder to a known location on your computer
3. Double-click the Un-Zipped Orchid Update program and firmware package to install on your computer
4. Turn on the Orchid unit to be upgraded
5. Connect the OR-SM module to your computer
6. Insert the OR-SM module into the Service port
7. Run the Orchid Update program

8. Click Update
- The Updater will check for available software
- Compare it to the current version
- Perform the update.

Notes:

- The update process will take approximately 8 minutes.
- If the Update program does not automatically detect your Orchid model you will be asked to choose the appropriate model from a drop down list then click Update again.
- Clicking on Details allows you to monitor the update process



Warranty

Marshall Electronics warrants to the first consumer that this OR-701A LCD monitor will, under normal use, be free from defects in workmanship and materials, when received in its original container, for a period of one year from the purchase date. This warranty is extended to the first consumer only, and proof of purchase is necessary to honor the warranty. If there is no proof of purchase provided with a warranty claim, Marshall Electronics reserves the right not to honor the warranty set forth above. Therefore, labor and parts may be charged to the consumer. This warranty does not apply to the product exterior or cosmetics. Misuse, abnormal handling, alterations or modifications in design or construction void this warranty. It is considered normal for a minimal amount of pixels, not to exceed three, to fail on the periphery of the display active viewing area. Marshall Electronics reserves the option to refuse service for display pixel failure if deemed unobtrusive to effective use of the monitor by our technicians. No sales personnel of the seller or any other person is authorized to make any warranties other than those described above, or to extend the duration of any warranties on behalf of Marshall Electronics, beyond the time period described above. Due to constant effort to improve products and product features, specifications may change without notice.

Marshall Electronics, Inc.

1910 East Maple Avenue

El Segundo, CA 90245

Tel.: (800) 800-6608 / (310) 333-0606

Fax: (310)333-0688

www.LCDracks.com / sales@lcdracks.com

2010 - 0625 V 1.2