

# Marshall Electronics

Model **V-R902DLW**

Dual 9" Desktop and Rack Mount Dual Link / Waveform Monitor

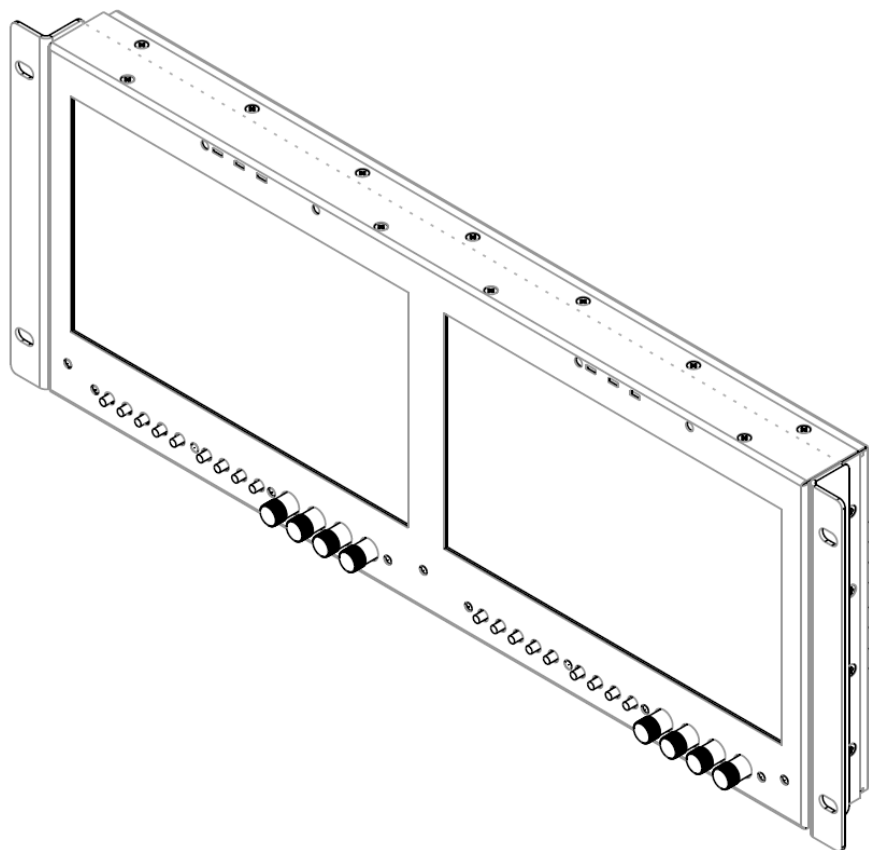

## Operating Instructions

Edition 2 Revision 0W

Page intentionally left blank

# Table of Contents

Installation and Initial Setup .....	5
Top and Front Panel Features .....	7
Rear Panel Features .....	8
Compatible Input Formats .....	9
MAIN MENU AND NAVIGATION .....	10
Using the RotoMenu knob .....	10
Marker Setup Submenu .....	10
Video Config Submenu .....	13
Audio Config Submenu .....	16
Color Config Submenu .....	17
System Config Submenu .....	17
OSD Config Submenu .....	19
IMD Config Submenu .....	22
IMD Fixed Config Submenu .....	24
Closed Captioning Submenu .....	25
Wave/Vector Submenu .....	26
Ancillary Submenu .....	28
Service Submenu .....	29
Specifications .....	31
Dimensions .....	32
Maintenance .....	34
Warranty .....	34

Page intentionally left blank

# Installation and Initial Setup

## ■ Unpacking

Carefully unpack the V-R902DLW monitor and verify that the following items are included:

- V-R902DLW Monitor
- V-PS12V-5A-2 Power Supply
- Operating Instructions

Inspect the unit for any physical damage that may have occurred during shipping. Should there be any damage, immediately contact Marshall Electronics at (800) 800-6608. If you are not located within the continental United States, call +1 (310) 333-0606.

## ■ Installation

The V-R902DLW can be mounted in any standard EIA 19" equipment rack. The attached rack ears can be angled to provide the user control over the viewing angle. Adequate ventilation is required when installed to prevent possible damage to the monitor's internal components. Please see the [Dimensions](#) section for more information.

## ■ Connections, Power-On and Initial Setup

Plug the power supply into an AC power source (100-240 V @ 50/60 Hz). Attach the Power connector to the back of the monitor. Connect the required cables for video signal input and output. (Power must be applied to the V-R902DLW for the active loop-through output to be activated.) The monitor defaults to 'ON' when power is supplied. Video will automatically be detected and displayed on the screen.

Page intentionally left blank

# Top and Front Panel Features

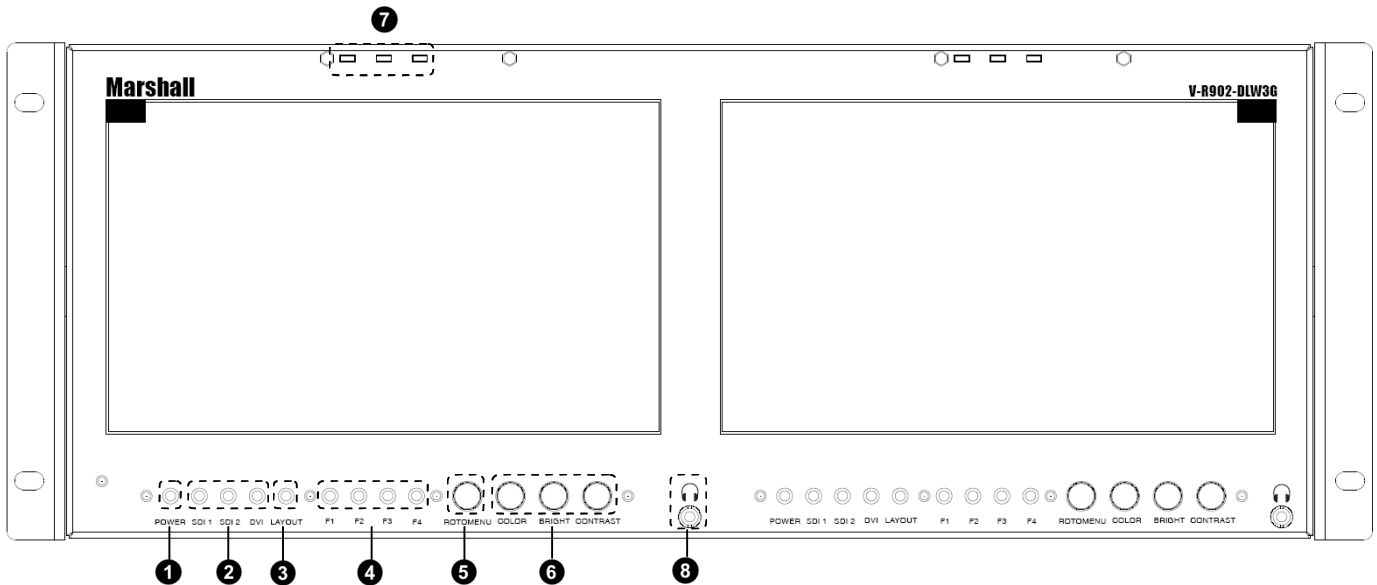

## 1 Power Button

Use the power button to toggle between ON and STANDBY modes. The LED on the POWER button will illuminate fully when the unit is in STANDBY mode. The LED will dim when the unit is ON.

## 2 Input Select Buttons (SDI 1, SDI 2, DVI)

Use the SDI 1, SDI2 and DVI buttons to select the corresponding video input. Accepted video standards are automatically detected.

## 3 Layout Button

Use the Layout button to switch between the four available layouts on the monitor. See the Layouts section for more information the available layouts.

## 4 User-Definable Function Buttons

Four user-definable function buttons can be used for direct access to various settings. Functions are assigned using the on-screen menu.

## 5 RotoMenu™ Knob

The RotoMenu™ knob allows for accessing and navigating the main menu using only a single knob.

## 6 Image Adjustment Knobs

Use the image adjustment knobs to adjust color brightness, color-saturation, tint, and contrast of the image. The status of each image adjustment parameter is shown on the bottom left of the screen, with values ranging from 0 to 100. Default value is 50.

## 7 LED Tally

Three LED tally lights (yellow, red, green) are available above the screen.

## 8 Headphone Output

The 1/8" jack on the monitor takes two channels of embedded SDI audio and provides a Headphone audio signal. Volume can be adjusted via the RotoMenu knob or in the Audio Configuration submenu.

# Rear Panel Features

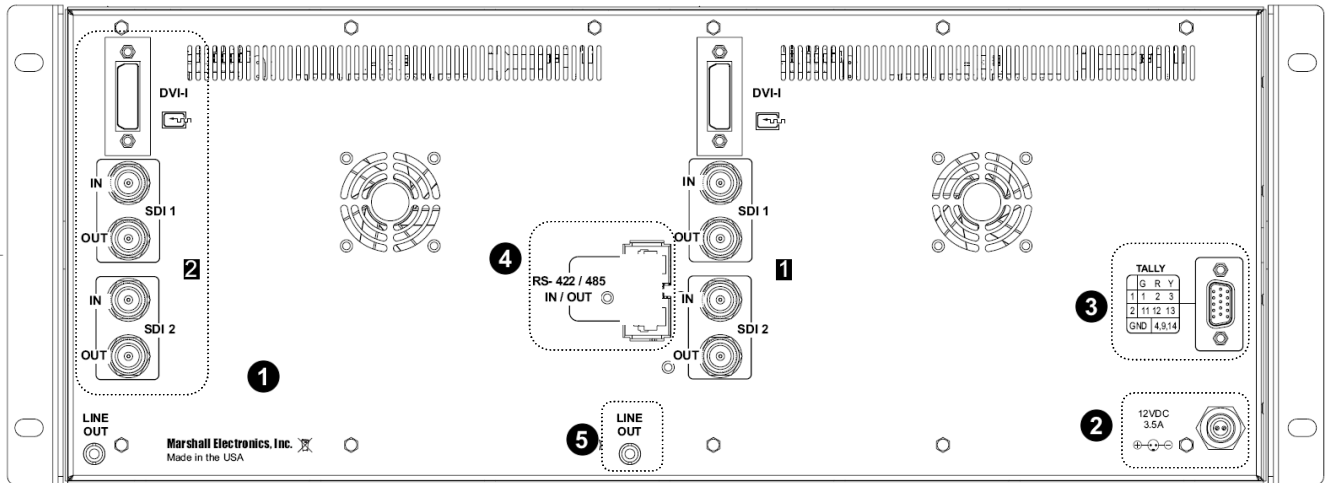

## ❶ SDI Inputs / Outputs and DVI-I Input

The V-R902DLW has two 3G-SDI inputs and two active loop-through outputs. SDI 1 and SDI 2 can be used simultaneously to display Dual Link SDI signals. The DVI-I Input Connector includes EDID and HDCP for connection to computers, DVD Players, Rasterizers, etc.

## ❷ Power Input

Connect the 2-pin Twist-Lock power input connector here. Power should only be supplied from the included power supply.

**IMPORTANT:** If using a power source other than the included power supply, damage may result. Please use the pin out diagram in the [Specifications](#) section.

## ❸ Tally Input / GPI Connector

The LED tally can be activated via the [HD-15 connector](#) by connecting the corresponding pin to ground. A variety of external devices can be used to perform the contact closure. The HD-15 connector can also be used as a GPI port by changing the settings in the On Screen Menu. No additional power should be supplied to the HD-15 port.

## ❹ RS-422/RS-485 Serial Interface

The RS-422/485 ports are used to remotely control the IMD or all DLW features. (Note: Connector/pin-out may need to be adapted depending on the protocol and controlling device used). Only one connection to either port is needed to control the monitors. The second port can be used to loop multiple monitors in the same bus.

## ❺ Line Out

The Line Out 1/8" jack on the back of the monitor takes two channels of embedded SDI audio and provides a Line Level audio signal. See the [Audio Configuration](#) section for instructions on how to select the two audio channels.



# Compatible Input Formats

The following video standards are supported by the V-R902DLW:

## **SDI Inputs**

525i, 625i/50

720p/29.97, 30, 50, 59.94, 60

1080p/23.98, 23.98sF, 24, 24sF, 25, 29.97, 30

1035i/59.94, 60

1080i/ 50, 59.94, 60

## **3G – Level A and Level B**

**YCbCr, YCbCr+A, RGB, RGB+A**

1080p/ 60, 59.94, 50

1080p/ 30, 29.97, 25, 24, 23.98, 30sF, 29.97sF, 25sF, 24sF, 23.98sF

1080i/ 60, 59.94, 50

## **3G – Level A and Level B**

**YCbCr, YCbCr+A, RGB, RGB+A**

1080p/ 60, 59.94, 50

1080p/ 30, 29.97, 25, 24, 23.98, 30sF, 29.97sF, 25sF, 24sF, 23.98sF

1080i/ 60, 59.94, 50

## **Dual Link**

**YCbCr, YCbCr+A, RGB, RGB+A**

1080p/ 60, 59.94, 50

1080i/ 60, 59.94, 50

1080p/30, 29.97, 25, 24, 23.98, 30sF, 29.97sF, 24sF, 23.98sF

## **2K**

1080p/ 30, 29.97, 25, 24, 23.98

## **DVI-I Input (DVI-Analog and DVI-Digital)**

640 x 480/ 60

800 x 600/ 60

1024 x 768/ 60

1280 x 1024/ 60

1600 x 1200/ 60

## **Video standards (HDMI or YPbPr over DVI connector)**

720p/50, 59.94, 60

1080i/50, 59.94, 60

1080p/23.98, 24, 25, 29.97, 30, 50, 59.94, 60

# MAIN MENU AND NAVIGATION

Access and navigate the main menu using the RotoMenu™ knob:

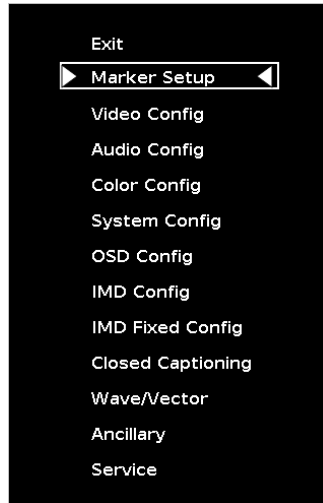

*Main Menu*

## Using the RotoMenu knob

- Press the **RotoMenu™** knob to enter the main menu.
- Rotate the knob to scroll up or down in the main menu or each submenu.
- Press the **RotoMenu™** knob to enter a submenu or choose a setting.
- To return to main menu from submenu, select 'Back' and press the **RotoMenu™**.

The menu timeout can be set in the OSD Timeout section of the OSD Config submenu.

## **Marker Setup Submenu**

Use the Marker Setup submenu to select various on-screen markers, adjust the Marker Background, or toggle the Center Marker ON or OFF.

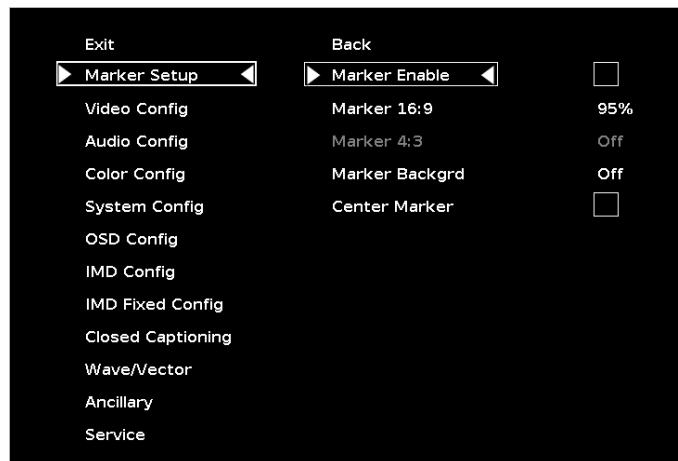

*Marker Setup Submenu*

## ■ Marker Enable

Use this function to enable or disable screen markers.

Using a function key or switching marker settings from the menu will automatically enable the markers.

## ■ 16:9 Markers

Use this setting to superimpose one of 10 markers on the screen when in 16:9 or Full Screen mode. This setting is disabled when the aspect ratio is set to 4:3, or when Pixel-to-Pixel mode is enabled. Note that in Full Screen mode, markers are vertically stretched along with the picture to fit the 16:10 screen.

- Off (No Marker)
- 95% Safe Area
- 93% Safe Area
- 90% Safe Area
- 88% Safe Area
- 80% Safe Area
- 1.85:1 Aspect Ratio
- 2.35:1 Aspect Ratio
- 4:3 Aspect Ratio
- 14:9 Aspect Ratio
- 13:9 Aspect Ratio

### 16:9 Marker Examples:

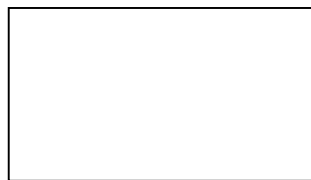

*OFF (No Marker)*

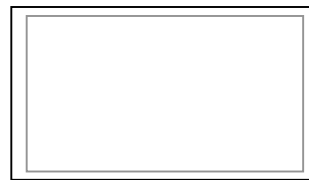

*90% Safe Area*



*2.35:1 Aspect Ratio*

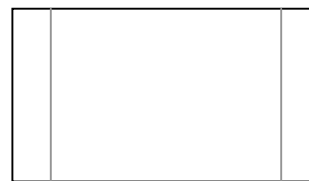

*4:3 Aspect Ratio Marker*

## ■ 4:3 Markers

Use this setting to superimpose one of 5 markers on the screen when in 4:3 mode. This setting is disabled when the aspect ratio is set to 16:9 or Full Screen, and when Pixel-to-Pixel mode is enabled.

- Off (No Marker)
- 95% Safe Area
- 93% Safe Area
- 90% Safe Area
- 88% Safe Area
- 80% Safe Area

#### 4:3 Marker Examples:

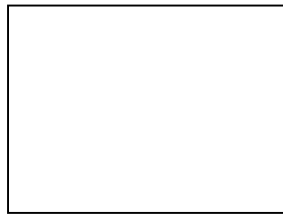

*OFF (No Marker)*

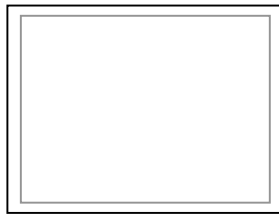

*90% Safe Area*

#### ■ Marker Background

Use this setting to choose how selected markers are displayed on the screen:

- Off The marker is superimposed on the complete image.
- 50% Gray Screen area beyond the marker is shown at 50% intensity.
- Black Screen area beyond the marker is shown as black.

#### Example (80% Marker in 4:3 Mode):

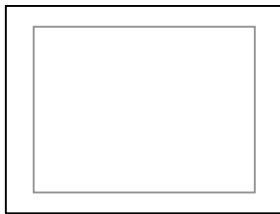

*Background OFF*



*50% Gray Background*



*Black Background*

#### ■ Center Marker

Use this setting to display a center marker on the screen.



*Center Marker*

## Video Config Submenu

Use the Video Configuration submenu to select various video settings such as monochrome mode or blue-only mode.

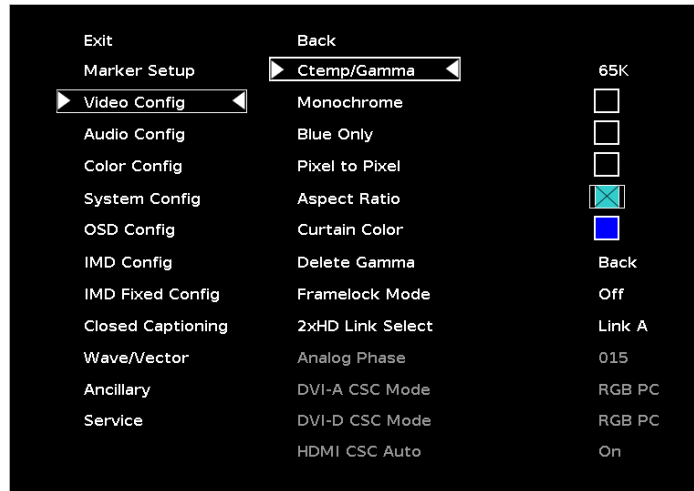

Video Configuration Submenu

### ■ CTemp/Gamma

Use this setting to choose one of three color temperature / gamma presets:

- D55 (5500K)
- D65 (6500K)
- D93 (9300K)
- Linear (No gamma applied)

### ■ Monochrome Mode

Use this setting to enable monochrome mode. Only the luminance of the image will be displayed as a grayscale picture.

### ■ Blue-Only Mode

Use this setting to enable Blue-Only mode. This mode displays only the blue color component of the image, switching off the red and green components. Use this mode when calibrating the monitor to SMPTE color bars with the following procedure:

1. Allow the monitor to warm up for at least 5-10 minutes.
2. Display SMPTE split-field color bars on the monitor using an external source.
3. Enable **Monochrome mode**.
4. Locate the pluge pattern (super black, black, and gray bars) at the lower-right corner of the screen. Adjust the **Brightness** knob until there is no visible difference between the super black and black bars, but the gray bar is still visible.
5. Adjust the **Contrast** knob until an even grayscale appears along the top bars.
6. Disable **Monochrome mode**.
7. Enable **Blue-Only mode** and adjust the **Color** knob so that the outermost bars (white and blue) appear to match in brightness.

## ■ Pixel-to-Pixel Mode

Use this setting to enable Pixel-to-Pixel mode.

This mode bypasses the monitor's internal scaling function and displays images in their native resolution and aspect ratio, with a one-to-one mapping of incoming image pixels to screen pixels:

- For incoming formats smaller than the native resolution of the window (or selected aspect ratio), the image will be displayed in the center of the window using only the necessary LCD pixels. For example, 480i images will only occupy exactly 640x480 pixels in a particular channel window in DLW mode, or if the channel is selected full screen, it will occupy exactly 640x480 pixels in the center of the screen. The surrounding screen area will be black.

## ■ Aspect Ratio Settings

Use this menu option to switch between several aspect ratio settings.

As the V-R902DLW monitor has a native resolution of 1366x768 RGB pixels, incoming images are automatically scaled to fit the screen:

- In **4:3** mode, images are scaled up or down to fill the maximum 4:3 portion of the screen. IMD text and time code are superimposed on the lower portion of the image. The audio presence indicator and on-screen tally are displayed at the bottom of the screen, outside the image.
- In **Scaled 4:3** mode, images are scaled to a smaller 4:3 portion of the screen, leaving space for IMD text, tally, and audio presence indicator to be displayed below or around the image. Time code is superimposed on the lower portion of the image.
- In **16:9** mode, images are scaled to fill the maximum 16:9 portion at the top of the screen. In this mode, IMD text and on-screen tally are displayed below the image. Time code and the audio presence indicator are superimposed on the lower portion of the image.
- In **Full Screen (16:10)** mode, images are scaled to fill the entire 16:10 screen. In this mode, all OSD features are superimposed on the image. **Note that when using a 16:9 input image in this mode, the image will be vertically stretched by approximately 10%.**

The diagrams on the following show how IMD text, timecode, and the audio monitor icon are simultaneously displayed on the screen in each aspect ratio setting. The white area represents the video image.

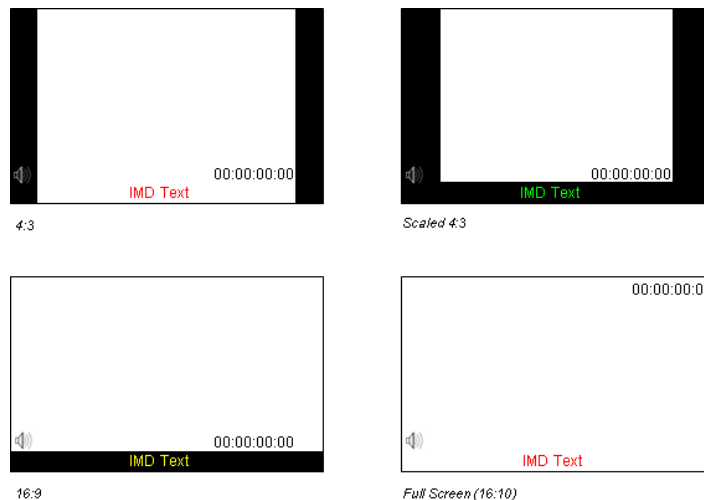

## ■ **Curtain Color**

Use this setting to choose the default color displayed on the screen when no video input is present. Available colors are **blue**, **red**, **green**, **white**, and **black**.

## ■ **Delete Gamma**

Use this function to delete any customized User calibration that has been loaded on to the system via Marshall Electronics' custom calibration application. Please contact Marshall Electronics for more information.

## ■ **Framelock Mode**

Framelock is used to designate the selected input as a reference for synchronizing image scaling when using the DLW monitor. This allows the monitor to use a known-stable input source as a reference-lock to the entire system. In some conditions, turning OFF the framelock mode will reduce the time needed for image lock.

## ■ **2xHD Link Select**

When displaying a 2xHD over 3G signal, this function allows you to select between the Link A and Link B channel. When the signal is not a valid 2xHD signal, this function will do nothing.

## ■ **Analog Phase (DVI-Analog or VGA input only)**

Adjusts the analog phase value to improve picture quality on DVI-A or VGA Sources. This adjusts the signal phase (not color phase) of the analog-to-digital conversion.

- 0-31 (value)

## ■ **DVI-A CSC Mode (DVI-Analog input only)**

Use the DVI-A CSC Mode to accommodate for four different types of colorspace inputs. This setting will only affect your DVI-A inputs.

- RGB Studio: accommodates digital 480i video using the RGB limited range (16-235) inputs.
- RGB PC: accommodates full range RGB (0-255) inputs.
- YUV 601: accommodates for Rec. 601 SDTV YUV colorspace inputs.
- YUV 709: accommodates for Rec. 709 HDTV YUV colorspace inputs.

The monitor's default setting is RGB PC.

## ■ **DVI-D CSC Mode (DVI-D input only)**

Use the DVI-D CSC Mode to accommodate for four different types of colorspace inputs. This setting will only affect your DVI-D and HDMI inputs.

- RGB Studio: accommodates digital 480i video using the RGB limited range (16-235) inputs.
- RGB PC: accommodates full range RGB (0-255) inputs.
- YUV 601: accommodates for Rec. 601 SDTV YUV colorspace inputs.
- YUV 709: accommodates for Rec. 709 HDTV YUV colorspace inputs.

The monitor's default setting is RGB PC.

## ■ HDMI CSC Auto (HDMI input only, via the DVI-I interface)

The HDMI CSC Auto setting is used to accommodate newer HDMI interfaces that send colorspace signaling in the HDMI data stream. If this setting is set to On, the monitor will automatically determine which colorspace setting to use. If this setting is set to Off, or your HDMI signal does not contain colorspace signaling, the DVI-D CSC Mode described above will determine the colorspace configuration.

## Audio Config Submenu

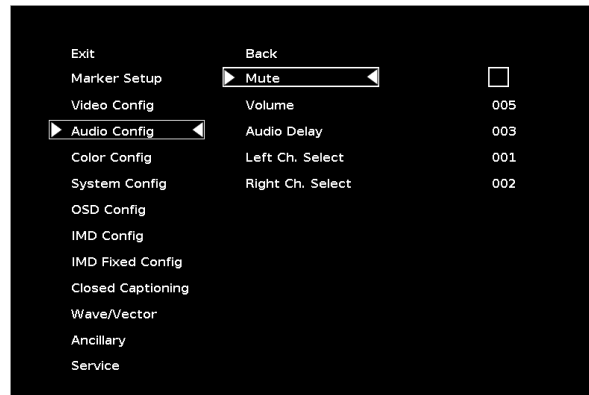

### ■ Mute

The Mute function disables audio output from Headphone output on the IMD 3G monitor. *This will not control the Line Out level of the monitor, only the Headphone output.*

### ■ Volume

The Volume control determines the output level for the Headphone out on the IMD-3G monitor.

### ■ Audio Delay

The Audio Delay function applies a delay to the Audio Metering and audio output. Use the function to select a delay between 000 and 015 (in terms of fields, or frames if the signal is progressive).

### ■ Left Ch. Select

Use this setting to select which of the 16 possible channels you would like to play on the **Left** side of the stereo output.

### ■ Right Ch. Select

Use this setting to select which of the 16 possible channels you would like to play on the **Right** side of the stereo output.



## Color Config Submenu

Use the Color Configuration submenu to adjust the Red, Green and Blue Offset and Gain values of the two SDI channels, the DVI-D input and DVI-A input.



For the DVI-I input, you can adjust the Offset and Gain for either a DVI-D or DVI-A input.

The Reset option allows you to return to the default settings for each individual channel.

## System Config Submenu

Use the System Configuration submenu to control various system parameters.

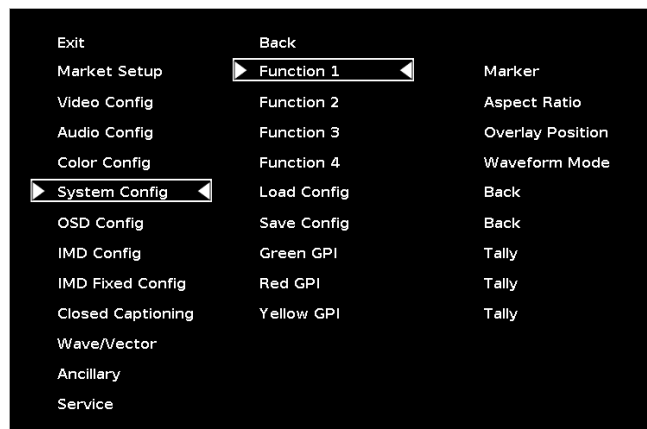

System Configuration Submenu

### ■ User-Definable Function Buttons

Use the **Function 1**, **Function 2**, **Function 3** and **Function 4** menu items to define each function button on the front panel of the monitor. Alternatively, you can save a preset to either of the function buttons by holding down F1, F2, F3 or F4 for 5 seconds. The following options are available for each button:

- Marker Toggle between different Screen Markers
- Center Marker Display/hide the Center Marker
- Marker Enable Display/hide on screen markers
- Marker Backgrd Change how markers are displayed on the screen
- IMD State Display/hide IMD text
- Anc. Time Code Display/hide time code
- OSD Tally Rotate amongst types of OSD Tally
- Audio Monitor Display/hide audio presence indicator
- CC Monitor Display/hide the Closed Caption Presence indicator
- Waveform Mode Change the data displayed on the Waveform monitor
- Overlay Position Change the position of the WFM Overlay in DLW Overlay Mode
- Limits Toggle the Limits option of the Waveform Monitor On or Off
- User 1 Recall User settings in the User 1 configuration
- User 2 Recall User settings in the User 2 configuration
- User 3 Recall User settings in the User 3 configuration
- User 4 Recall User settings in the User 4 configuration
- User 5 Recall User settings in the User 5 configuration
- User 6 Recall User settings in the User 6 configuration
- Aspect Ratio Toggle between 4:3 and 16:9 aspect ratios
- Pixel to Pixel Enable/disable Pixel-to-Pixel mode
- Ctemp/Gamma Rotate amongst color temperature settings
- Blue Only Enable/disable Blue Only mode
- Monochrome Enable/disable Monochrome mode

## ■ Saving and Loading User Presets

Use the SAVE CONFIG and LOAD CONFIG menus to save current settings to one of 6 presets, or load a preset. Each Preset saves all monitor settings except for IMD configuration. Alternatively, you can save a preset to either of the function buttons by holding down F1, F2, F3 or F4 for 5 seconds.

- Use the LOAD CONFIG menu to load one of presets USR1 – USR6. Factory default settings can also be loaded by selecting MFG. (Factory defaults cannot be overwritten.)
- Use To perform a full system restore, which resets ALL adjustable fields on the monitor to their “fresh-from-factory” state, press the Power, F1 and F2 button simultaneously. **Note: You will lose ALL user adjustable settings on your monitor.**
- Use the SAVE CONFIG menu to save the current settings to a preset from USR1- USR6.

## ■ Green, Red, Yellow GPI

Use the GPI settings to determine the function of a specific Tally pin on the back of the unit. The GPI Pin actions are toggled by bringing the pin LOW. The Red, Green or Yellow Tally pins can activate a variety of settings, listed below.

- Tally Illuminate Green, Red or Yellow Tally LED
- Monochrome Enable/disable Monochrome mode
- Blue Only Enable/disable Blue Only mode
- Pixel to Pixel Enable/disable Pixel to Pixel mode
- CC Monitor Display/hide Closed Caption Presence indicator
- Audio Monitor Display/hide Audio Presence indicator
- OSD Tally Rotate amongst types of OSD Tally
- IMD State Display/hide IMD text
- CTemp/Gamma Rotate amongst CTemp/Gamma presets
- Layout Toggle between the available DLW layouts
- Aspect Ratio Toggle between 4:3 and 16:9 aspect ratios

- Anc. Time Code Display/hide time code
- Marker Level Rotate amongst marker settings

The following settings are activated only when the Green, Red or Yellow Pin is brought into a LOW state by connecting it with one of the GND pins. Once the Tally Pin is brought HIGH again (remove the connection to GND), the settings will be deactivated.

- Monochrome (L) Rotate amongst color temperature settings
- Markers (L) Enable/disable Blue Only mode
- Marker Mask 50% (L) Enable/disable Monochrome mode
- Marker Mask Black (L) Enable/disable Blue Only mode
- Marker Center(L) Enable/disable Monochrome mode

## OSD Config Submenu

Use the OSD Configuration submenu to select a variety of information to be displayed on the screen.

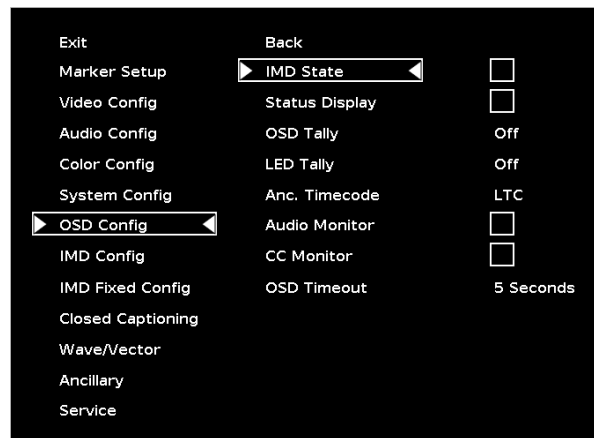

OSD Configuration Submenu

### ■ IMD State

Use this setting to turn the IMD text display on or off. This setting affects both fixed string IMD text and remote IMD text commands.

### ■ Status Display

Use this setting to enable or disable status display. When enabled, the current video input standard is displayed on the top left of the screen. When disabled, status is only displayed for 2 seconds when the monitor is powered on, when an input is applied, or when the input video standard changes. The status display reads “No Input” when no video input is present.

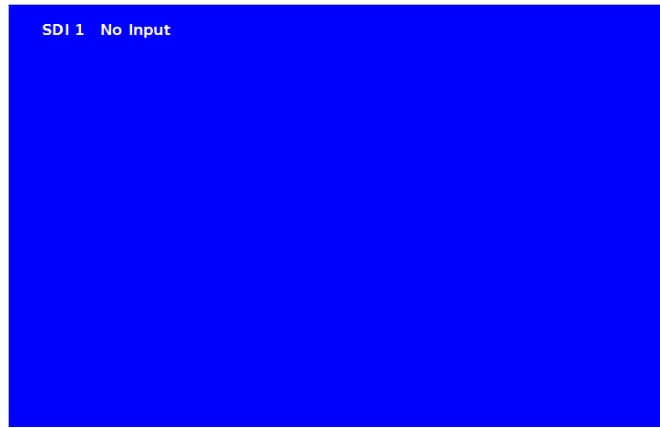

Status Display

## ■ OSD Tally

Use this setting to choose how tally is displayed on the screen. The available OSD Tally options depend on the Tally Source selected in the IMD Configuration submenu

When the Tally Source is set to Standard (contact closure), OSD Tally can be set to **Off**, **RGY**, **RG**, or **GR**:

- **Off** On-screen tally is disabled
- **RGY** Red, yellow, or green tally signals are indicated at both the bottom left and bottom right corners of the screen. Two or three colors are shown simultaneously by subdividing each tally indicator
- **RG** Red tally is shown at the bottom left of the screen, and green is shown at the bottom right.
- **GR** Green tally is shown at the bottom left of the screen, and red is shown at the bottom right.

The following diagrams show RGY, RG, and GR OSD Tally modes:

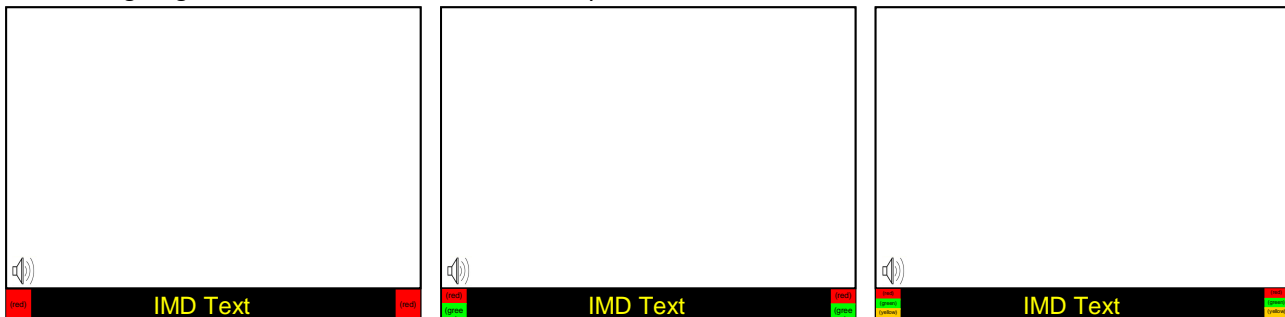

RGY mode: single color activated

RGY mode: two colors activated

RGY mode: three colors activated

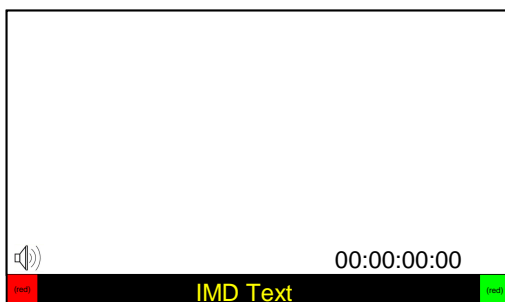

RG Mode: both colors activated

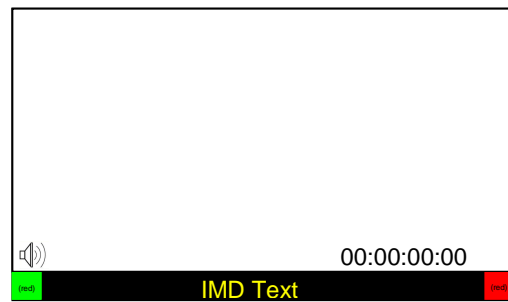

GR Mode: both colors activated

When the Tally Source is set to TSL/MEI 422, OSD Tally can be set to **Off** or **IMD**:

- Off On-screen tally is disabled
- IMD Red, yellow, and green tally is displayed according the protocol commands. Green, red, and yellow colors are shown individually on either the bottom left or right of the screen.

### ■ LED Tally

Use this to enable or disable the physical LED tally on the top of the monitor.

### ■ Anc. Timecode

Use this setting to enable time code display on the screen. Time code is de-embedded from the vertical ancillary data (VANC) within the HD/SDI signal. Two types of time code can be selected to display on the screen: **LTC (linear time code)** or **VITC (vertical interval time code)**.

The position of the time code display varies based on the aspect ratio setting and presence of IMD text.

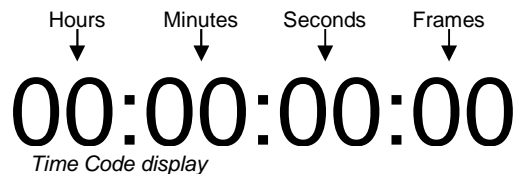

### ■ Audio Monitor

Use the Audio Monitor menu option to enable or disable the audio presence indicator icon. When enabled, this icon indicates whether embedded audio is present in the HD/SDI video input. A red circle and cross will flash on the icon if no embedded audio is present.

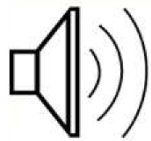

*Embedded Audio Present*



*No Embedded Audio*

### ■ CC Monitor (Closed Captioning)

Use the CC Monitor menu option to enable or disable the Closed Captioning presence indicator icon. When enabled, this icon indicates the presence of 608 and/or 708 embedded Closed Captioning in the SDI video input. A **green** dot indicates the presence of CC Data. A **red** dot indicates no captioning data.



*Both 608 and 708 CC Data present*

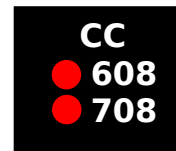

*No CC Data present*

## ■ OSD Timeout

Use the OSD Timeout setting to set the amount of time you would like to see the Menu on screen. Selectable values range from **5** to **30 Seconds** in 5 second increments. A value of **None** allows the menu to stay on screen until it is manually exited.

## IMD Config Submenu

### ■ Overview

The V-R902DLW features an In-Monitor Display (IMD) with the ability to display on-screen text and tally in three colors. IMD text, color, and alignment can be assigned to each screen locally using menu options (see below). Alternately, IMD text and tally can be remotely controlled via the RS-422/485 serial interface using several industry-standard protocols, including TSL v4.0 and Image Video. Multiple V-R902DLW monitors can be looped together and each addressed individually via the protocol. All menu features of the V-R902DLW can also be controlled via the Marshall Network Controller box using MEI protocol. (Contact Marshall Electronics for additional information).

Use the IMD Configuration submenu to configure various IMD parameters as described below.

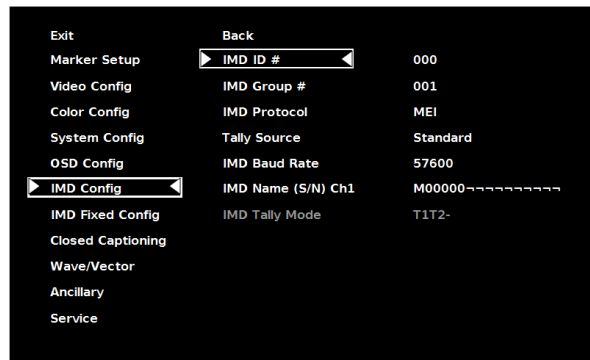

*IMD Configuration Submenu*

### ■ IMD ID #

The IMD ID # identifies each screen to the controlling device. When using the TSL protocol, the ID # of each screen should be manually set in conjunction with the controlling device. When using the Image Video protocol, the ID # may be set automatically by the controlling device, after each IMD is initially identified by IMD Name (see “IMD Name[S/N]” below). Available ID #s are **000-254**.

### ■ IMD Group #

Each screen can be assigned an IMD Group # when using the Marshall protocol. Available Group #s are **01-254**.

### ■ IMD Protocol

Use the IMD Protocol menu option to choose the protocol with which the V-R902DLW receives remote commands. Currently, four protocols are available. Contact Marshall Electronics for the latest protocol compatibility.

#### Image Video

Use the Image Video protocol setting when controlling the IMD from an Image Video tally controller (e.g. TSI-1000) or other controlling device which utilizes the Image Video protocol. The **IMD #**, **IMD Name(S/N)**, and **Baud Rate** parameters must be set for each screen in conjunction with the controlling device.

### TSL v4.0

Use the TSL v4.0 protocol setting when controlling the IMD from a TSL tally controller, or other controlling device which utilizes the TSL v4.0 protocol. The IMD # must be set for each screen in conjunction with the controlling device.

### MEI

Use the MEI protocol setting when controlling the V-R902DLW using the Marshall Network Controller box. This protocol allows remote control of all features on the V-R902DLW, including marker setup, video configuration, system configuration, and image adjustments (brightness, contrast, etc.). The **IMD #**, **IMD Group #**, and **Baud Rate** parameters must be set in conjunction with the Network Controller Box.

### MEI-Image Video

This protocol setting accepts Image Video commands *via* MEI protocol, for use when an Image Video controller is connected to the Marshall Network Controller box.

## ■ Tally Source

The V-R902DLW OSD tally can be controlled in a variety of different ways. Use the Tally Source setting to choose how tally is controlled:

### Standard

Use the Standard setting to control tally via contact closure on the HD-15 tally interface.

### Image Video HW

Use the Image Video HW setting to control Image Video tally states via contact closure on the HD-15 tally interface. Contact closure of the **Red** pin corresponds to **Image Video Tally 1**, and the **Green** pin maps to **Image Video Tally 2**. Contact closure (ground) corresponds to a LOW state, and open circuit corresponds to a HIGH state. This mode requires the IMD Tally Mode parameter to be set. Consult Image Video documentation for further information.

### Image Video 422

Use the Image Video 422 setting to control Image Video tally states via the Image Video serial protocol. OSD tally will be disabled in this mode, as Image Video tally states are manifested in the text color and other parameters. This mode requires the IMD Tally Mode parameter to be set. Consult Image Video documentation for further information.

### Standard + IV422

Use the Image Video 422 setting to control Image Video tally states via the Image Video serial protocol, while controlling OSD tally using contact closure on the HD-15 tally interface. This mode requires the IMD Tally Mode parameter to be set. Consult Image Video documentation for further information.

### TSL/MEI 422

Use the TSL/MEI 422 setting to control OSD tally via the TSL or Marshall serial protocols.

## ■ IMD Baud Rate

Use this setting to choose the baud rate. The baud rate must be set in conjunction with the controlling device. Available baud rates are **300, 600, 1200, 2400, 4800, 9600, 19200, 38400, 57600, 115200**. The TSL v4.0 protocol is fixed at 38400 bauds.

## ■ IMD Name (S/N)

Use this setting to assign a name to each screen when using the Image Video or Marshall-IV protocols. ***The IMD name is equivalent to the Image Video serial number and is used by the Image Video controlling device to identify each screen.*** The default IMD Name(S/N) is "M00000." It is recommended to maintain this naming scheme in order to avoid serial number conflicts with other Image Video devices on the same serial bus. Each name can be up to 16 ASCII characters.

Press RotoMenu™ knob to edit the IMD Name. Rotate the RotoMenu™ knob to move the cursor. Press the RotoMenu™ knob with the cursor on the character to be changed, then rotate the knob to scroll through the character set. Press the RotoMenu™ knob to choose a character.

## ■ IMD Tally Mode

Use this setting when using Image Video tally control. Choose one of the following settings, in conjunction with the Image Video controlling device. **T1, T2, T1T2, T2T1, T1-, T2-, T1T2-, T2T1-**. Consult Image Video documentation for further information.

## IMD Fixed Config Submenu



IMD Fixed Configuration Submenu

## ■ IMD Fixed Color

Use this setting to choose the color of the IMD Fixed String text (see below). Available colors are **red, green, and yellow**. This setting does not affect text color when using IMD text via the Image Video or TSL v4.0 protocols (text color is set via the protocols).

## ■ IMD Fixed Align

Use this setting to choose the horizontal alignment of the IMD text. IMD text can be justified on the **left, center or right** of the screen. This setting is overridden when using IMD text via the Image Video protocol (alignment is set via Image Video protocol).

## ■ IMD Fixed String

Use this setting to display static IMD text on the screen. This setting is used to enter IMD text locally, when a serial protocol is not used for remote control. The IMD Fixed String is saved after power cycle. *The IMD Fixed String will be overridden by serial protocol commands.*

Press RotoMenu™ knob to edit the IMD Fixed String. Rotate the RotoMenu™ knob to move the cursor. Press the RotoMenu™ knob with the cursor on the character to be changed, then rotate the knob to scroll through the character set. Press the RotoMenu™ knob to choose a character. The '-' character indicates an unused (NULL) value in the string. The string entered will



be terminated by the first '-'. Characters to the right of a '-' character will be displayed in the menu, but will not be shown in the IMD string.

## Closed Captioning Submenu

Use the Closed Captioning submenu to select the type of captioning stream you would like to decode.

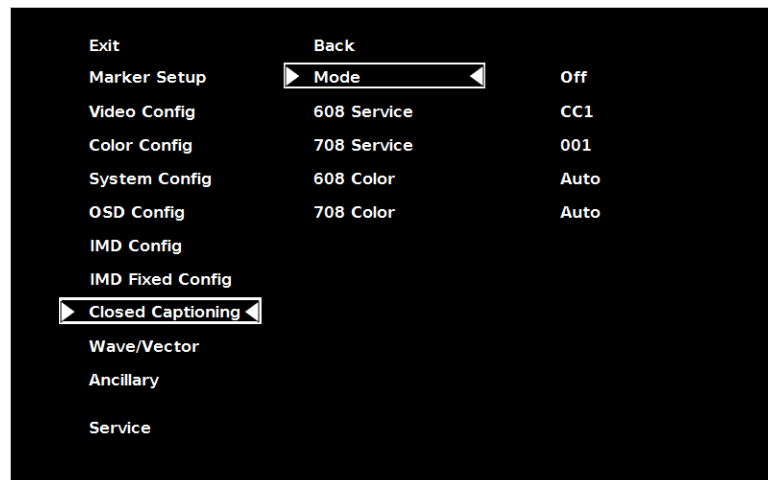

*Closed Captioning Submenu*

### ■ Mode

The DLW monitor series provides support for three types of Closed Captioning Modes: 608, 708 and 708 (608 Comp.). Use this section to choose which type of stream you would like to decode.

### ■ 608 Service

The EIA-608 caption protocol defines four channels of caption information. The V-R902DLW monitor can only display one of these four channels at any point in time. With the 608 Service selection, you can select which of the four streams to render on the screen.

### ■ 708 Service

Similar to the EIA-608 caption protocol, the EIA-708 caption protocol can contain multiple streams of captions. These streams are labeled with a service ID. This menu option allows you to select which service to render on the screen.

### ■ 608 Color

The EIA-608 caption protocol can define the color for the closed caption text. Use this setting to choose between using the color defined by the data stream or to override this data with any of the selected colors.

The default setting for option is Auto.

### ■ 708 Color

The EIA-708 caption protocol can also define the color for the closed caption text. Use this setting to choose between using the color defined by the data stream or to override this data with any of the selected colors.

The default setting for option is Auto.

## Wave/Vector Submenu

Use the Wave/Vector submenu to change the location of the Waveform Monitor and Vectorscope, as well as the data displayed on the Waveform monitor or the Vectorscope on the V-R902DLW monitor. The Waveform Monitor can also be customized to conform to different scales, to display different colors, differentiate data with Limits. The Vectorscope targets can also be changed in this menu.

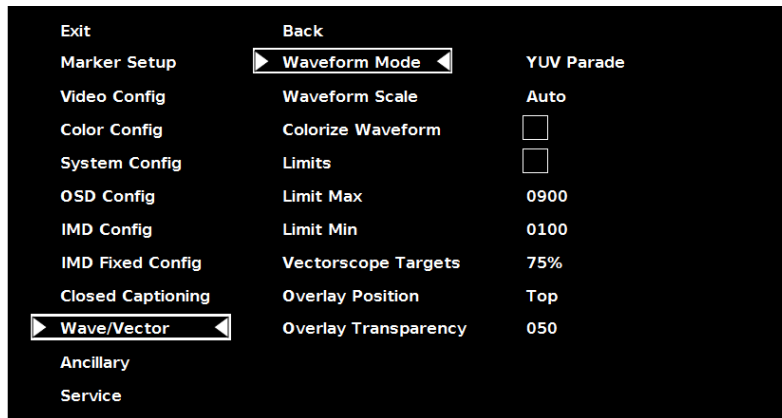

### Waveform Mode

This option allows you to choose between different layouts for the Waveform monitor. Available options are YUV Parade, YUV Overlay, RGB Parade and RGB Overlay.

- YUV Parade The Y (Luminance, shown in white), U and V (Chrominance components, U is showed in cyan and V is shown in Magenta) components of the signal are displayed from left to right.

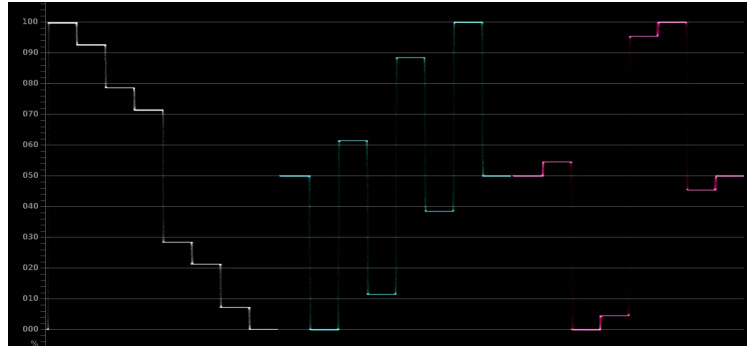

- YUV Overlay The YUV components of the signal are overlaid.

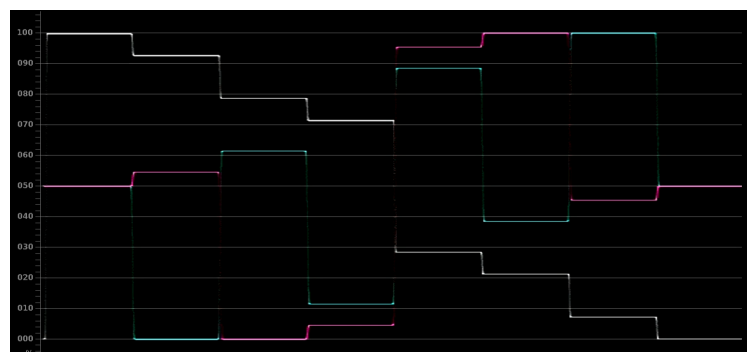

- **RGB Parade** The R (shown in Red), G (shown in Green) and B (shown in Blue) components of the signal are displayed from left to right.

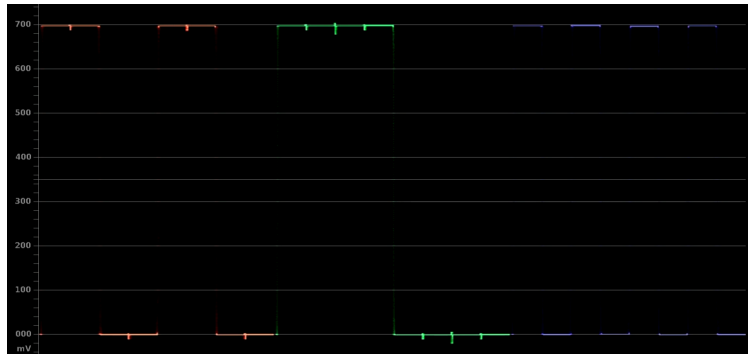

- **RGB Overlay** The RGB components of the signal are overlaid.

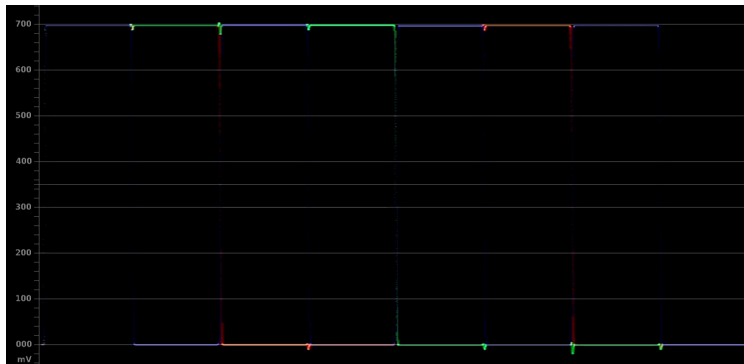

## ■ Waveform Scale

Use the Waveform scale option to switch between different graticule units on the Waveform display. Available options are mV, %IRE, Auto and Off.

## ■ Colorize Waveform

Use the Colorize Waveform option to add or remove color from the Waveform display. When Colorize Waveform is ON, the YUV and RGB data components on the Waveform display will appear in different colors. When Colorize Waveform is OFF, all YUV and RGB data components will appear as white on the Waveform display.

## ■ Limits

Use the Limits option to differentiate data (indicated by a red highlight) on the Waveform display that goes above a Limit Max (maximum) and goes below a Limit Min (minimum) set in the Wave/Vector submenu. The Limit maximum and minimum can be set from 0000 to 1023. Note: Setting the Limits option to ON will override the Colorize Waveform option. All Waveform display data within the limits will appear in white.

## ■ Limit Max

Use this to set the desired maximum for the Limit display of the waveform monitor. Any Waveform data that goes beyond this Limit Max will be displayed in red.

## ■ Limit Min

Use this to set the desired minimum for the Limit display of the waveform monitor. Any Waveform data that goes below this Limit Max will be displayed in red.

## ■ Vectorscope Targets

Use the Vectorscope Targets option to set your Vectorscope targets up for 75% or 100% color bar signals. You can also set your Vectorscope Targets to the OFF position.

## ■ Overlay Position

Use the Overlay Position option to place the Waveform, Vectorscope and Audio Level display on the Top or Bottom of the screen while in the DLW Overlay display mode. You can also set your Overlay display to OFF.

## ■ Overlay Transparency

Use the Overlay Transparency option to set the transparency of the Waveform, Vectorscope and Audio Level display while in DLW Overlay mode. Choose a value from 000-100. A low value will cause the Waveform, Vectorscope and Audio Level data to blend into the background, while a high value will make the data appear more visible against the video display in the background.

## Ancillary Submenu

Use the Ancillary submenu to determine which ancillary packet IDs should be counted in the Ancillary Status portion of the DLW monitor display.

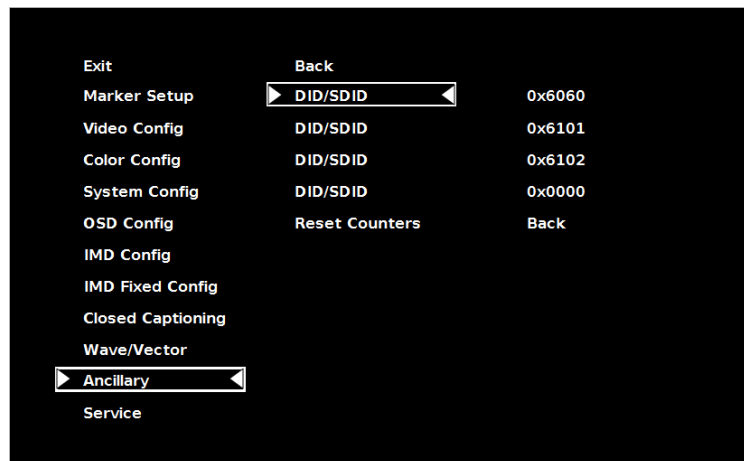

## ■ DID/SDID

Use this section to select which packet IDs should be counted on the DLW monitor display. For example, 0x6060 would count the Timecode data packets, 0x6101 would count the EIA-708 CC data packets and 0x6102 would count the EIA-608 CC data packets. Any ancillary packet ID can be chosen, from 0000 to FFFF.

## Service Submenu

### ■ Software Version Display

The Main Board, Keypad, and FPGA software version numbers are displayed.



Service Menu

The following information is displayed:

- rel: Release Package version number
- ipa Input processor firmware
- dlw FPGA Version
- ipap Product Type
- kp Keypad version number

Page intentionally left blank

# Specifications

## ■ PANEL

Screen Size	9" Diagonal
Display Area (h x v)	193.92 x 116.35 mm
Pixels	1280 x RGB x 768
Viewing Angle (h x v)	170° x 170°
Brightness	350 cd/m <sup>2</sup>
Contrast Ratio	1000:1

## ■ CONNECTORS (Per Panel)

### Video Input

3G-SDI 2 x BNC Female (75 Ω)

### Video Output (Active Loop-Through)

3G-SDI 2 x BNC Female (75 Ω)

### DVI Input

DVI-I 1 x DVI-I Female Connector

### Power Input

2-Pin Twist-Lock

### Tally / GPI Hardware Interface

HD-15 Female

### RS-422/485 Interface (Per Unit)

2 x RJ12 (Modular 6P6C)

## ■ TALLY Hardware Interface (HD-15)

Protocols: Image Video, TSL v4.0, MEI



Pin	Function
1	Tx-
2	Ground
3	Rx+ (Receive from host)
4	Rx- (Receive from host)
5	N/C
6	Tx+

Activation requires contact closure of pin to ground on the HD-15 connector:

**TALLY**

	G	R	Y
1	1	2	3
2	11	12	13
GND	4,9,14		

## ■ ELECTRICAL

Power Consumption 3.5A @ 12VDC (42 W)

Voltage Requirement 12 VDC

Pinout



## ■ MECHANICAL

Weight (with rack ears): 6.75 lbs

Operating Temperature 32°F to 104°F (0°C to 40°C)

Storage Temperature -4°F to 120°F (-20°C to 50°C)

See [Dimensions](#) section for exact specifications.

# Dimensions

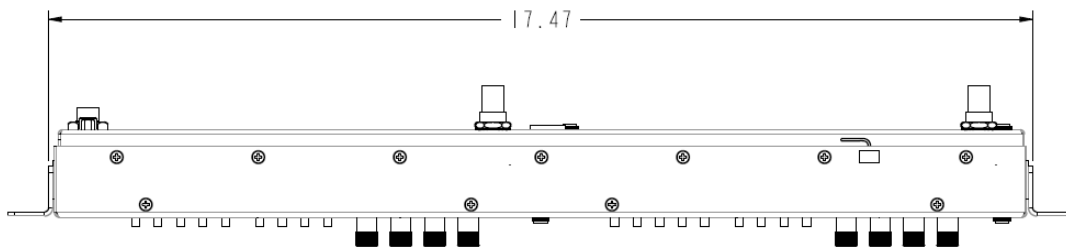
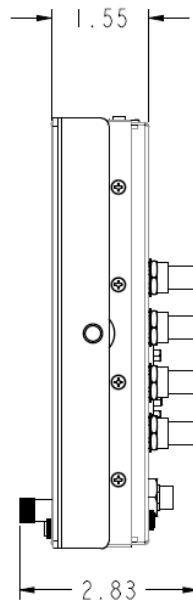
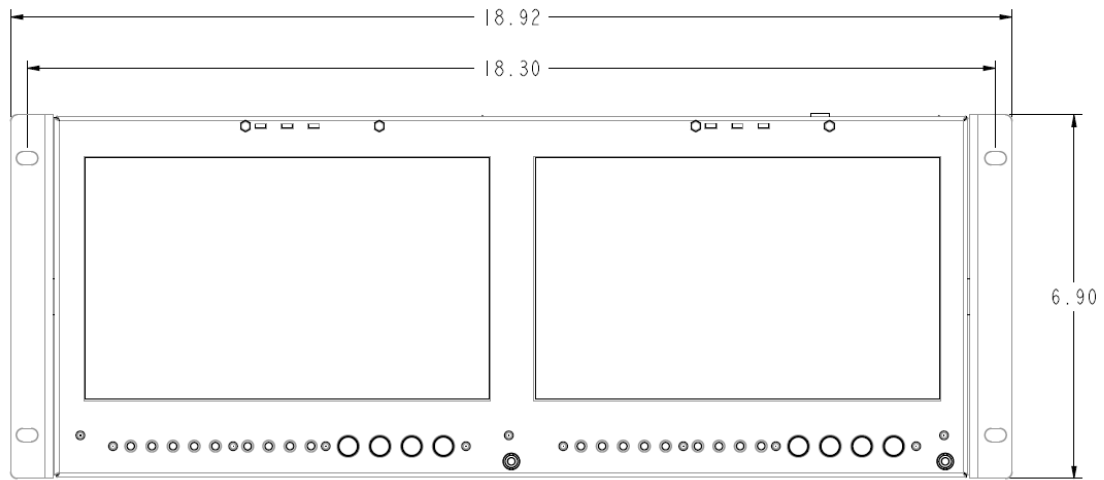



Page intentionally left blank

# Maintenance

## ■ Screen Cleaning

Periodically clean the screen surface using ammonia-free cleaning wipes (Marshall Part No. V-HWP-K). A clean micro-fiber cloth can also be used using only non-abrasive and ammonia-free cleaning agents. Do not use paper towels. Paper towel fibers are coarse and may scratch the surface of the polycarbonate faceplate or leave streaks on the surface. Antistatic and fingerprint resistant cleaning agents are recommended. Do not apply excessive pressure to the screen to avoid damaging the LCD.

## ■ Faceplate Dusting

Dust the unit with a soft, damp cloth or chamois. Dry or abrasive cloths may cause electrostatic charge on the surface, attracting dust particles. Neutralize static electricity effects by using the recommended cleaning and polishing practice.

# Warranty

Marshall Electronics warrants to the first consumer that this V-R902DLW LCD monitor will, under normal use, be free from defects in workmanship and materials, when received in its original container, for a period of one year from the purchase date.

This warranty is extended to the first consumer only, and proof of purchase is necessary to honor the warranty. If there is no proof of purchase provided with a warranty claim, Marshall Electronics reserves the right not to honor the warranty set forth above. Therefore, labor and parts may be charged to the consumer. This warranty does not apply to the product exterior or cosmetics. Misuse, abnormal handling, alterations or modifications in design or construction void this warranty. It is considered normal for a minimal amount of pixels, not to exceed three, to fail on the periphery of the display active viewing area. Marshall Electronics reserves the option to refuse service for display pixel failure if deemed unobtrusive to effective use of the monitor by our technicians. No sales personnel of the seller or any other person is authorized to make any warranties other than those described above, or to extend the duration of any warranties on behalf of Marshall Electronics, beyond the time period described above. Due to constant effort to improve products and product features, specifications may change without notice.

Page intentionally left blank

**Marshall Electronics, Inc.**  
1910 East Maple Ave.  
El Segundo, CA 90245  
Tel: (800) 800-6608 / (310) 333-0606 • Fax: 310-333-0688  
[www.LCDRacks.com](http://www.LCDRacks.com) • [sales@lcdracks.com](mailto:sales@lcdracks.com)